

CONTRACT

PART C1: AGREEMENTS AND CONTRACT DATA

PART C2: PRICING DATA

PART C3: SCOPE OF WORK

PART C4: SITE INFORMATION

CONTRACT

TABLE OF CONTENTS	Page	Colour
PART C1: AGREEMENTS AND CONTRACT DATA		
C1.1: FORM OF OFFER AND ACCEPTANCE	C3	Yellow
C1.1.1: OFFER	C3	Yellow
C1.1.2: ACCEPTANCE.....	C4	Yellow
C1.1.3: SCHEDULE OF DEVIATIONS	C5	Yellow
C1.2: CONTRACT DATA	C7	Yellow
C1.2.1: CONDITIONS OF CONTRACT	C7	Yellow
C1.2.2: DATA PROVIDED BY THE EMPLOYER	C10	Yellow
C1.2.3: DATA PROVIDED BY THE CONTRACTOR	C15	Yellow
C1.3: PERFORMANCE GUARANTEE.....	C16	White
C1.4: AGREEMENT IN TERMS OF SECTION 37(2) OF THE OCCUPATIONAL HEALTH AND SAFETY ACT NO. 85 OF 1993	C19	White
C1.5: RETENTION MONEY GUARANTEE	C21	White
C1.6: TRANSFER OF RIGHTS.....	C23	White
PART C2: PRICING DATA		
C2.1: PRICING ASSUMPTIONS	C24	Yellow
C2.2: BILL OF QUANTITIES.....	C28	Yellow
PART C3: SCOPE OF WORK		
TABLE OF CONTENTS.....	C44	Blue
C3.1: STANDARD SPECIFICATIONS	C45	Blue
C3.2: PROJECT SPECIFICATIONS.....	C45	Blue
C3.3: PARTICULAR SPECIFICATIONS	C80	Blue
PART C4: SITE INFORMATION		
C4.1: LOCALITY PLAN.....	C137	Green
C4.2: EXAMPLE OF CONTRACT SIGNBOARD DETAILS	C138	Green
C4.3: EXISTING SERVICES REPORT.....	C140	Green
C4.4: CONDITIONS ON SITE: MATERIALS INFORMATION	C141	Green
ANNEXURE A: GUIDELINES FOR CONSTRUCTION AND MAINTENANCE PROJECTS DURING COVID-19 LOCKDOWN		
	146	White

PART C1: AGREEMENTS AND CONTRACT DATA

C1.1: FORM OF OFFER AND ACCEPTANCE

C1.1.1: OFFER

The Employer, identified in the Acceptance signature block, has solicited offers to enter into a contract in respect of the following works:

CONTRACT NO. ZNB0068/00000/00/ESH/INF/21/T: BETTERMENT AND REGRAVELLING OF P708 FROM KM 0.8 TO KM 4.3 IN THE EMPANGENI REGION

The Tenderer, identified in the Offer signature block below, has examined the documents listed in the Tender Data and addenda thereto as listed in the Tender Schedules, and by submitting this Offer has accepted the Conditions of Tender.

By the representative of the Tenderer, deemed to be duly authorised, signing this part of this Form of Offer and Acceptance, the Tenderer offers to perform all of the obligations and liabilities of the Contractor under the Contract including compliance with all its terms and conditions according to their true intent and meaning for an amount to be determined in accordance with the Conditions of Contract identified in the Contract Data.

The offered total of the prices inclusive of Value Added Tax is:

Amount in Words.....

.....
.....

R..... (in figures).

This Offer may be accepted by the Employer by signing the Acceptance part of this Form of Offer and Acceptance and returning one copy of this document to the Tenderer before the end of the period of validity stated in the Tender Data, whereupon the Tenderer becomes the party named as the Contractor in the Conditions of Contract identified in the Contract Data.

Signature: (of person authorised to sign the tender)

Name: (of signatory in capitals)

Capacity: (of signatory)

Name of Tenderer: (organisation)

Address:

.....

Telephone number: **E-mail:**

Witness:

Signature:

Name: (in capitals)

Date:

[Failure of a Tenderer to sign this form will invalidate the tender]

This form is to be completed by the Employer only

C1.1.2: ACCEPTANCE

By signing this part of the Form of Offer and Acceptance, the Employer, identified below, accepts the Tenderer's Offer. In consideration thereof, the Employer shall pay the Contractor the amount due in accordance with the Conditions of Contract identified in the Contract Data. Acceptance of the Tenderer's Offer shall form an agreement between the Employer and the Tenderer upon the terms and conditions contained in this Agreement and in the Contract, that is the subject of this Agreement.

The terms of the contract are contained in

- Part C1 Agreements and Contract Data (which includes this Agreement)
- Part C2 Pricing Data
- Part C3 Scope of Work
- Part C4 Site Information

and the schedules, forms, drawings and documents or parts thereof, which may be incorporated by reference into Parts C1 to C4 above.

Deviations from and amendments to the documents listed in the Tender Data and any addenda thereto listed in the Tender Schedules as well as any changes to the terms of the Offer agreed by the Tenderer and the Employer during this process of offer and acceptance, are contained in the Schedule of Deviations attached to and forming part of this Agreement. No amendments to or deviations from said documents are valid unless contained in this Schedule, which must be duly signed by the authorised representatives of both parties.

The Tenderer shall within two weeks after receiving a completed copy of this Agreement, including the Schedule of Deviations (if any), contact the Employer's Agent (whose details are given in the Contract Data) to arrange the delivery of any bonds, guarantees, proof of insurance and any other documentation to be provided in terms of the Conditions of Contract identified in the Contract Data at, or just after, the date this Agreement comes into effect. Failure to fulfil any of these obligations in accordance with those terms shall constitute a repudiation of this Agreement.

Notwithstanding anything contained herein, this Agreement comes into effect on the date when the Tenderer receives one fully completed original copy of this document, including the Schedule of Deviations (if any). Unless the Tenderer (now Contractor) within five days of the date of such receipt notifies the Employer in writing of any reason why he cannot accept the contents of this Agreement, this Agreement shall constitute a binding contract between the parties.

Signature:

Name: *(in capitals)*

Capacity:

Name of Employer: *(organisation)*

Address:
.....

Witness: Signature: **Name:** *(in capitals)*

Date:

the documents listed in the Tender Data and addenda thereto as listed in the Tender Schedules, as well as any confirmation, clarification or change to the terms of the offer agreed by the Tenderer and the Employer during this process of offer and acceptance.

It is expressly agreed that no other matter whether in writing, oral communication or implied during the period between the issue of the tender documents and the receipt by the Tenderer of a completed signed copy of this Agreement shall have any meaning or effect in the contract between the parties arising from this Agreement.

FOR THE TENDERER:

Signature:

Name:

Capacity:

Tenderer: *(Name and address of organisation)*

.....

Witness:

Signature:

Name:

Date:

FOR THE EMPLOYER:

Signature:

Name:

Capacity:

Employer: *(Name and address of organisation)*

.....

Witness:

Signature:

Name:

Date:

C1.2: CONTRACT DATA

C1.2.1: CONDITIONS OF CONTRACT

C1.2.1.1 GENERAL CONDITIONS OF CONTRACT

This Contract will be based on the 'General Conditions of Contract for Construction Works, Third Edition (2015)', issued by the South African Institution of Civil Engineering (abbreviated title: 'GCC 2015').

It is agreed that the only variations from the GCC 2015 are those set out hereafter under "C1.2.1.2 SPECIAL CONDITIONS OF CONTRACT".

C1.2.1.2 SPECIAL CONDITIONS OF CONTRACT

C1.2.1.2.1 GENERAL

These Special Conditions of Contract (SCC) form an integral part of the Contract. The Special Conditions of Contract shall amplify, modify or supersede, as the case may be, the GCC 2015 to the extent specified below, and shall take precedence and shall govern.

The clauses of the Special Conditions of Contract hereafter are numbered "SCC" followed in each case by the number of the applicable clause or subclause in the GCC 2015, and the applicable heading, or (where a new special condition that has no relation to the existing clauses is introduced) by a number that follows after the last clause number in the GCC 2015, and an appropriate heading.

C1.2.1.2.2 AMENDMENTS TO THE GCC 2015

SCC 1.1 Definitions

SCC 1.1.1.14: *delete* "Commencement Date" *in the definition and substitute* "date of commencement of the Works".

Add the following to the end of Clause 1.1:

"SCC 1.1.1.35 "Construction Manager" means the person approved of in writing by the Employer's Agent, as the Contractor's representative on Site.

SCC 1.1.1.36 "Targeted Enterprise" means an enterprise as defined in Part G: Small Contractor Development of section C3.3 Particular Specifications in Part C3: Scope of Work.

SCC 1.1.1.37 "Targeted Labour" means labour as defined in Part G: Small Contractor Development of section C3.3 Particular Specifications in Part C3: Scope of Work."

SCC 4.1.1 Extent of Contractor's obligations

Add the following new paragraphs to the end of Clause 4.1.1:

"If the Contractor fails to achieve the monetary value of the contract participation goal stated in the Contract Data for local labour content in terms of Part F: Expanded Public Works Programme of section C3.3 Particular Specifications in Part C3: Scope of Work, the Contractor shall be liable to the Employer for a sum calculated in accordance with the Contract Data and the aforementioned Scope of Work as a penalty for such underachievement.

If the Contractor fails to achieve the monetary value of the contract participation goal stated in the Contract Data for contract participation by Targeted Enterprises in terms of Part G: Small Contractor Development of section C3.3 Particular Specifications in Part C3: Scope of Work, the Contractor shall be liable to the Employer for a sum calculated in accordance with the Contract Data and the aforementioned Scope of

Work as a penalty for such underachievement.”

SCC 4.4.2 Subcontractor to be approved

Add the following to Clause 4.4.2:

“The Contractor shall comply with the subcontracting restrictions stated in the Contract Data.”

SCC 4.10.1 Engagement of employees

Add the following to Clause 4.10.1:

“The contractor shall pay rates and wages, and observe conditions of labour, which are not lower than those established for the trade or industry where the work is carried out, as stated in the Contract Data.”

SCC 5.3.1 Commencement of the Works

Delete the first sentence of Clause 5.3.1 and substitute the following:

“The Employer’s Agent shall give the Contractor not less than 7 days’ notice of the date of commencement of the Works on which date the Contractor is instructed to commence carrying out the Works, save as may be otherwise provided in the Contract, or be legally or physically impossible. The date of commencement of the Works shall be within the period after the Commencement Date stated in the Contract Data.”

SCC 5.3.3 Time to instruct commencement of the Works

Delete Clause 5.3.3.

SCC 5.14.4 Certification of Completion

Insert the following in the first sentence after the words “has been duly completed,”:

“and the Contractor has submitted the information stated in the Contract Data,”.

SCC 5.14.6 Occupation by the Employer

Add the following to Clause 5.14.6:

“The use of any completed roadway or parts of the Works, whether for unhindered use by the public or for accommodation of traffic, while other parts are being constructed, shall not constitute occupation of the Works by the Employer.”

SCC 6.2.1 Delivery of security

In the last two lines of Clause 6.2.1, delete the words “the type of security for the due performance of the Contract, as selected in the Contract Data” and replace them with the words “a fixed performance guarantee as security for the due performance of the Contract in accordance with the Contract Data Part A: Data Provided by the Employer”.

Delete the entirety of Clause 6.2.2 and replace it with the following:

“SCC 6.2.2 Contractor failing to provide security

If the Contractor fails to provide the required fixed performance guarantee within the time period stated in the Contract Data, or if the performance guarantee shall differ substantially from the pro forma, it shall legally be deemed that the Contractor has selected a security of ten per cent retention of the value of the Works without limiting the Employer’s right to terminate the Contract in terms of Clause 9.2.”

SCC 6.2.3 Validity of performance guarantee

Delete the entirety of the first sentence of Clause 6.2.3 and replace it with the following:

“The Contractor shall ensure that the performance guarantee remains valid and enforceable until the Certificate of Completion is issued.”

SCC 6.10.4 Delivery, dissatisfaction with and payment of payment certificate

Delete “within 28 days” in the third sentence and substitute “within 30 days”.

SCC 6.10.8 Contractor’s completion statement

Delete “within 28 days” in the third sentence and substitute “within 30 days”.

SCC 6.10.9 Final Payment Certificate

Delete “within 28 days” in the second sentence and substitute “within 30 days”.

SCC 10.1.5 Employer’s Agent’s ruling on Contractor’s Claim

Delete “within 28 days” in the first sentence and in Clause 10.1.5.1, and substitute “within 56 days”.

C1.2.2: DATA PROVIDED BY THE EMPLOYER

The following contract specific data are applicable to this contract.

CLAUSE	CONTRACT SPECIFIC DATA PROVIDED BY THE EMPLOYER														
<p>1.</p> <p>1.1.1.13</p> <p>SCC 1.1.1.14</p> <p>1.1.1.26</p> <p>1.1.1.15</p> <p>1.2.1.2</p> <p>1.1.1.16</p> <p>1.2.1.2</p>	<p>GENERAL</p> <p>The Defects Liability Period is 12 months.</p> <p>The time for achieving Practical Completion is 3 <u>months</u> from the date of commencement of the Works, including non-working days and special non-working days.</p> <p>Pricing Strategy: The Contract is to be a Re-measurement Contract.</p> <p>Name of Employer: Province of KwaZulu-Natal represented by Head of Department: Department of Transport</p> <p>Address of Employer:</p> <table border="0"> <tr> <td><u>Physical</u></td> <td><u>Postal:</u></td> </tr> <tr> <td>24 John Ross Street Eshowe 3815</td> <td>Private Bag X 527 Eshowe 3815</td> </tr> <tr> <td>Telephone No: (033) 355 8600</td> <td>Fax No: (033) 342 4082</td> </tr> </table> <p>Name of Employer's Agent: HN Consulting Engineers Thabani Mjadu</p> <p>Address of Employer's Agent:</p> <table border="0"> <tr> <td><u>Physical:</u></td> <td><u>Postal:</u></td> </tr> <tr> <td>Block B, Hilltops Office Park 73 Villiers Drive, Pietermaritzburg 3201</td> <td>P.O. Box 13214 Cascades 3202</td> </tr> <tr> <td>E-Mail: pierre@hn.co.za</td> <td></td> </tr> <tr> <td>Telephone No: (033) 394 2352</td> <td>Fax No: (033) 394 2356</td> </tr> </table>	<u>Physical</u>	<u>Postal:</u>	24 John Ross Street Eshowe 3815	Private Bag X 527 Eshowe 3815	Telephone No: (033) 355 8600	Fax No: (033) 342 4082	<u>Physical:</u>	<u>Postal:</u>	Block B, Hilltops Office Park 73 Villiers Drive, Pietermaritzburg 3201	P.O. Box 13214 Cascades 3202	E-Mail: pierre@hn.co.za		Telephone No: (033) 394 2352	Fax No: (033) 394 2356
<u>Physical</u>	<u>Postal:</u>														
24 John Ross Street Eshowe 3815	Private Bag X 527 Eshowe 3815														
Telephone No: (033) 355 8600	Fax No: (033) 342 4082														
<u>Physical:</u>	<u>Postal:</u>														
Block B, Hilltops Office Park 73 Villiers Drive, Pietermaritzburg 3201	P.O. Box 13214 Cascades 3202														
E-Mail: pierre@hn.co.za															
Telephone No: (033) 394 2352	Fax No: (033) 394 2356														
<p>3.</p> <p>3.2.3</p>	<p>EMPLOYER'S AGENT</p> <p>The Employer's Agent is required to obtain the specific approval of the Employer before executing any of his functions or duties according to the following Clauses:</p> <p>SCC 5.3.1: Give the Contractor notice of the commencement date of the Works.</p> <p>6.3.1: Order any work as a Variation Order.</p> <p>6.3.1: Order any work which requires the utilisation of the provision for contingencies in the Contract Sum.</p> <p>6.3.1: Order any work which requires the Contract Price to exceed the Contract Sum.</p> <p>10.1.5: Ruling on a Contractor's claim.</p>														

CLAUSE	CONTRACT SPECIFIC DATA PROVIDED BY THE EMPLOYER
5.8.1	<p>licensed compensation insurer as contemplated in the Compensation for Occupational Injuries and Diseases Act, 1993 (Act No. 130 of 1993) (refer to Clause 4.3);</p> <p>(iv) Initial Programme (refer to Clause 5.6);</p> <p>(v) Security (refer to Clause 6.2); and</p> <p>(vi) Insurance (refer to Clause 8.6)</p> <p>(vii) Form C1.4 'Agreement in terms of Section 37(2) of the Occupational Health and Safety Act No. 85 of 1993' to be signed by the Contractor and the Employer (refer to Clause 4.3 of the GCC 2015 and to paragraph E9. CONTRACTOR'S RESPONSIBILITIES in Part E of C3.3 Particular Specifications)</p> <p>and if the Employer is required to apply for a construction work permit to perform construction work in terms of regulation 3(1) of the Construction Regulations 2014, the following documentation shall also be submitted:</p> <p>(vii) Temporary works designer's appointment duties in terms of Regulation 6(2) as have been agreed upon plus proof of registration with ECSA [CR 3(5)(b)(iii) read with CR 5(1)(e) and CR 6(2)];</p> <p>(viii) Evidence that the Principal contractor has made adequate provision for the cost of Health and Safety, i.e., bill of quantities [CR 3(5)(b)(iii) read with CR 5(1)(g)]; and</p> <p>(ix) Evidence that the Principal contractor has the necessary competencies to carry out construction work safely, namely, schedule of activities, relevant appointments and proofs of competency [CR 5(1)(h)].</p> <p>The non-working days are Sundays.</p> <p>The special non-working days are:</p> <p>(i) the statutory public holidays in terms of the Public Holidays Act;</p> <p>(ii) the foreseeable election days declared as a statutory public holiday; and</p> <p>(iii) the annual year-end shutdown period as recommended by the Bargaining Council for the Civil Engineering Industry.</p>
5.13.1	
5.14.1	
5.14.1	<p>The penalty for failing to complete the Works is 0,05% of the Contract Sum per day, up to a maximum limit of twenty-five thousand rand per day (R25 000,00 per day).</p>
SCC 5.14.4	<p>The requirements for achieving Practical Completion are as stated in General Conditions of Contract 2015.</p> <p>The Contractor shall submit the following:</p> <p>(i) evidence that the local labour has been paid, and that the Targeted Enterprise subcontractors have received all amounts due in terms of their respective subcontract agreements; and</p> <p>(ii) the survey and materials information which the Employer's Agent requires to complete the as-built drawings and records.</p> <p>The latent defects period is 10 years.</p>
6.	<p>PAYMENT AND RELATED MATTERS</p>
SCC 6.2.1	<p>The security to be provided by the Contractor shall be:</p> <p>Fixed Performance Guarantee of 8% of the first One Million Rand plus 3,5% of</p>

CLAUSE	CONTRACT SPECIFIC DATA PROVIDED BY THE EMPLOYER
6.5.1.2.3	<p>the balance of the Contract Sum.</p> <p>The percentage allowance to cover overhead charges is 10%.</p>
6.8.2	<p>The value of payment certificates issued shall be adjusted in accordance with the Contract Price Adjustment Schedule with the following data.</p> <p>The values of the coefficients for calculating the Contract Price Adjustment Factor are:</p> <p style="padding-left: 40px;">Routine maintenance – upgrade (Schedules A, D, F and G):</p> <p style="padding-left: 40px;">a = 0,48 b = 0,37 c = 0,05 d = 0,1</p> <p>“L”, “P”, “M” and “F” are defined as follows:</p> <p>“L” is the “Labour Index” and shall be the Consumer Price Index for “Geographic Indices > CPI per province > KwaZulu-Natal” as published in Table A of the Statistical Release P0141 of Statistics South Africa.</p> <p>“P” is the “Construction Equipment Index” and shall be the Construction Materials Price Index for “Plant and equipment” as published in Table 4 of the Statistical Release P0151.1 of Statistics South Africa.</p> <p>“M” is the “Materials Index” and shall be the Construction Materials Price Index as published in Table 6 of the Statistical Release P0151.1 of Statistics South Africa for:</p> <p style="padding-left: 40px;">Road works (Schedules A, D, F and G): “Civil engineering material – roads, general (excluding bitumen)”</p> <p style="padding-left: 40px;">Structures (Schedule B): “Civil engineering material – structures (excluding bitumen)”</p> <p>“F” is the “Fuel Index” and shall be the Producer Price Index for “Coke, petroleum, chemical, rubber and plastic products > Coal and petroleum products > Diesel” as published in Table 1 of the Statistical Release P0142.1 of Statistics South Africa.</p> <p>The base month is the month preceding the month of tender closure.</p> <p>Any index calculated by means of a linking factor between an old and new index, shall be rounded to one decimal place.</p> <p>Price adjustments for variations in the cost of bitumen as a special material are allowed.</p>
6.8.3	<p>Only the net bitumen content of asphalt and bituminous products shall be subject to variations in cost, and no account shall be taken of transport, emulsifiers, diluents or modifiers that may be supplied ex refinery or added later.</p> <p>The percentage advance on Plant and materials not yet built into the Permanent Works is 80%.</p> <p>The percentage retention on the amounts due to the Contractor is 10%.</p>
6.10.1.5	<p>The limit of retention money is 5% of the first One Million Rand plus 1,6% of the balance of the Contract Sum excluding contingencies, contract price adjustment, and VAT.</p>
6.10.3	

CLAUSE	CONTRACT SPECIFIC DATA PROVIDED BY THE EMPLOYER
	A retention guarantee in lieu of a cash retention is permitted.
<p>8.</p> <p>8.6.1.1.2</p> <p>8.6.1.1.3</p> <p>8.6.1.2</p> <p>8.6.1.3</p>	<p>RISKS AND RELATED MATTERS</p> <p>The value of Plant and materials supplied by the Employer to be included in the insurance sum is <u>nil</u>.</p> <p>The amount to cover professional fees for repairing or reinstatement of damage to the Works to be included in the insurance sum is <u>nil</u>.</p> <p>Special Risks Insurance issued by SASRIA is required.</p> <p>The limit of indemnity for liability insurance is <u>R10 000 000,00 (ten million Rand only)</u> for any single liability claim. Liability insurance shall include spread of fire risk.</p>
<p>10.</p> <p>10.5.2</p> <p>10.5.3</p> <p>10.8.1</p>	<p>CLAIMS AND DISPUTES</p> <p>Disputes shall be referred to ad-hoc adjudication.</p> <p>The number of Adjudication Board members to be appointed shall be one.</p> <p>Unresolved disputes shall be determined by court proceedings.</p>
	<p>DATA WITH REFERENCE TO C3.3 PARTICULAR SPECIFICATIONS</p>
<p>PART G</p> <p>G2.9</p>	<p>SMALL CONTRACTOR DEVELOPMENT</p> <p>The target area for local labour</p> <p>The target area for Targeted Enterprises</p>

C1.2.3: DATA PROVIDED BY THE CONTRACTOR

The following contract specific data are applicable to this contract.

CLAUSE	CONTRACT SPECIFIC DATA PROVIDED BY THE CONTRACTOR												
<p>1.</p> <p>1.1.1.9</p> <p>1.2.1.2</p>	<p>GENERAL</p> <p>Name of Contractor:</p> <p>Address of Contractor:</p> <table style="width: 100%; border: none;"> <tr> <td style="width: 50%; text-align: center;"><u>Physical:</u></td> <td style="width: 50%; text-align: center;"><u>Postal:</u></td> </tr> <tr> <td>.....</td> <td>.....</td> </tr> <tr> <td>.....</td> <td>.....</td> </tr> <tr> <td>.....</td> <td>.....</td> </tr> <tr> <td>.....</td> <td>.....</td> </tr> </table>	<u>Physical:</u>	<u>Postal:</u>		
<u>Physical:</u>	<u>Postal:</u>												
.....												
.....												
.....												
.....												
<p>6.</p> <p>6.8.3</p>	<p>PAYMENT AND RELATED MATTERS</p> <p>The tenderer shall complete the table below with respect to each of the special materials listed. This information shall be used to calculate the variation in cost of the special materials.</p> <p>The rates and prices for the special materials for the base month which is the month preceding the month of tender closure, shall exclude VAT but shall include all other obligatory taxes and levies.</p> <p>The tenderer shall append to this page a letter from the supplier confirming the supply price for the net bitumen content of asphalt and bituminous products.</p> <p>A change of supplier due to circumstances beyond the control of the Contractor may be considered, subject to the submission of supporting documentation to the Employer’s Agent for valuation to calculate the difference between the rate or price of the special material entered in the table below and the equivalent rate or price actually paid by the Contractor, and for approval.</p> <table border="1" style="width: 100%; border-collapse: collapse;"> <thead> <tr> <th style="width: 60%;">SPECIAL MATERIALS <i>Compiler to list bitumen types:</i></th> <th style="width: 10%;">UNIT</th> <th style="width: 30%;">RATE OR PRICE FOR THE BASE MONTH</th> </tr> </thead> <tbody> <tr> <td>35/50 penetration grade bitumen</td> <td style="text-align: center;">ton</td> <td style="text-align: center;">.....</td> </tr> <tr> <td>50/70 penetration grade bitumen</td> <td style="text-align: center;">ton</td> <td style="text-align: center;">.....</td> </tr> <tr> <td>70/100 penetration grade bitumen NIL (<i>if not applicable</i>)</td> <td style="text-align: center;">ton</td> <td style="text-align: center;">.....</td> </tr> </tbody> </table> <p>Signed on behalf of the Tenderer:</p>	SPECIAL MATERIALS <i>Compiler to list bitumen types:</i>	UNIT	RATE OR PRICE FOR THE BASE MONTH	35/50 penetration grade bitumen	ton	50/70 penetration grade bitumen	ton	70/100 penetration grade bitumen NIL (<i>if not applicable</i>)	ton
SPECIAL MATERIALS <i>Compiler to list bitumen types:</i>	UNIT	RATE OR PRICE FOR THE BASE MONTH											
35/50 penetration grade bitumen	ton											
50/70 penetration grade bitumen	ton											
70/100 penetration grade bitumen NIL (<i>if not applicable</i>)	ton											

C1.3: PERFORMANCE GUARANTEE

PRO FORMA

PERFORMANCE GUARANTEE

For use with the General Conditions of Contract for Construction Works, Third Edition (2015).

1. GUARANTOR DETAILS AND DEFINITIONS

“Guarantor” means:

Physical address:

“Employer” means:

“Contractor” means:

“Employer’s Agent” means:

“Works” means:

“Site” means:

“Contract” means: The Agreement made in terms of the Form of Offer and Acceptance and such amendments or additions to the Contract as may be agreed in writing between the parties.

“Contract Sum” means: The accepted amount inclusive of tax of R

Amount in words:

“Guaranteed Sum” means: The maximum aggregate amount of R

Amount in words:

“Expiry Date” means: or any other later date set by the Contractor and/or Employer provided such instruction is received prior to the Expiry Date as indicated here.

2. CONTRACT DETAILS

Employer’s Agent issues: Interim Payment Certificates, Final Payment Certificate and the Certificate of Completion of the Works as defined in the Contract.

3. GUARANTOR’S LIABILITY

3.1 The Guarantor’s liability shall be limited to the amount of the Guaranteed Sum.

3.2 The Guarantor’s period of liability shall be from and including the date on which the Performance Guarantee is signed, up to and including the Expiry Date, or the date of issue by the Employer’s Agent of the Certificate of Completion of the Works, or the date of payment in full of the Guaranteed Sum, whichever occurs first.

3.3 The Employer’s Agent and/or the Employer shall advise the Guarantor in writing of the date on which the Certificate of Completion of the Works has been issued.

4. CONDITIONS APPLICABLE TO THIS PERFORMANCE GUARANTEE

4.1 The Guarantor hereby acknowledges that:

4.1.1 Any reference in this Performance Guarantee to the Contract is made for the purpose of convenience and shall not be construed as any intention whatsoever to create an accessory obligation or any intention whatsoever to create a suretyship.

4.1.2 Its obligation under this Performance Guarantee is restricted to the payment of money.

4.2 Subject to the Guarantor's maximum liability referred to in 3.1, the Guarantor hereby undertakes to pay the Employer the sum certified upon receipt of the documents identified in 4.2.1 to 4.2.3:

4.2.1 A copy of a first written demand issued by the Employer to the Contractor stating that payment of a sum certified by the Employer's Agent in an Interim or Final Payment Certificate has not been made in terms of the Contract and failing such payment within seven (7) calendar days, the Employer intends to call upon the Guarantor to make payment in terms of 4.2.2;

4.2.2 A first written demand issued by the Employer to the Guarantor at the Guarantor's physical address with a copy to the Contractor stating that a period of seven (7) days has elapsed since the first written demand in terms of 4.2.1 and the sum certified has still not been paid;

4.2.3 A copy of the aforesaid payment certificate which entitles the Employer to receive payment in terms of the Contract of the sum certified in 4.2.

4.3 Subject to the Guarantor's maximum liability referred to in 3.1, the Guarantor undertakes to pay to the Employer the Guaranteed Sum or the full outstanding balance upon receipt of a first written demand from the Employer to the Guarantor at the Guarantor's physical address calling up this Performance Guarantee, such demand stating that:

4.3.1 the Contract has been terminated due to the Contractor's default and that this Performance Guarantee is called up in terms of 4.3; or

4.3.2 a provisional or final sequestration or liquidation court order has been granted against the Contractor and that the Performance Guarantee is called up in terms of 4.3; and

4.3.3 the aforesaid written demand is accompanied by a copy of the notice of termination and/or the provisional/final sequestration and/or the provisional liquidation court order.

4.4 It is recorded that the aggregate amount of payments required to be made by the Guarantor in terms of 4.2 and 4.3 shall not exceed the Guarantor's maximum liability in terms of 3.1.

4.5 Where the Guarantor has made payment in terms of 4.3, the Employer shall upon the date of issue of the Final Payment Certificate submit an expense account to the Guarantor showing how all monies received in terms of this Performance Guarantee have been expended and shall refund to the Guarantor any resulting surplus. All monies refunded to the Guarantor in terms of this Performance Guarantee shall bear interest at the prime overdraft rate of the Employer's bank compounded monthly and calculated from the date payment was made by the Guarantor to the Employer until the date of refund.

4.6 Payment by the Guarantor in terms of 4.2 or 4.3 shall be made within seven (7) calendar days upon receipt of the first written demand to the Guarantor.

4.7 Payment by the Guarantor in terms of 4.3 will only be made against the return of the original Performance Guarantee by the Employer.

4.8 The Employer shall have the absolute right to arrange his affairs with the Contractor in any manner which the Employer may consider fit and the Guarantor shall not have the right to claim his release from this Performance Guarantee on account of any conduct alleged to be prejudicial to the Guarantor.

- 4.9 The Guarantor chooses the physical address as stated above for the service of all notices for all purposes in connection herewith.
- 4.10 This Performance Guarantee is neither negotiable nor transferable and shall expire in terms of 3.2, where after no claims will be considered by the Guarantor. The original of this Guarantee shall be returned to the Guarantor after it has expired.
- 4.11 This Performance Guarantee, with the required demand notices in terms of 4.2 or 4.3, shall be regarded as a liquid document for the purposes of obtaining a court order.
- 4.12 Where this Performance Guarantee is issued in the Republic of South Africa the Guarantor hereby consents in terms of Section 45 of the Magistrates' Courts Act No 32 of 1944, as amended, to the jurisdiction of the Magistrate's Court of any district having jurisdiction in terms of Section 28 of the said Act, notwithstanding that the amount of the claim may exceed the jurisdiction of the Magistrate's Court.

Signed at

Date

Guarantor's signatory (1)

Capacity

Guarantor's signatory (2)

Capacity

Witness signatory (1)

Witness signatory (2)

C1.4: AGREEMENT IN TERMS OF SECTION 37(2) OF THE OCCUPATIONAL HEALTH AND SAFETY ACT NO. 85 OF 1993

THIS AGREEMENT is made between The Province of KwaZulu-Natal represented by Head of Department: Department of Transport (hereinafter called the EMPLOYER) of the one part, herein represented by:

.....

in his capacity as:

AND:

(hereinafter called the CONTRACTOR) of the other part, herein represented by:.....

.....

in his capacity as:

duly authorised to sign on behalf of the Contractor.

WHEREAS the CONTRACTOR is the Mandatary of the EMPLOYER in consequence of an agreement between the CONTRACTOR and the EMPLOYER in respect of:

CONTRACT NO. ZNB0068/00000/00/ESH/INF/21/T: BETTERMENT AND REGRAVELLING OF P708 FROM KM 0.8 TO KM 4.3 IN THE EMPANGENI REGION

for the construction, completion and maintenance of the works;

AND WHEREAS the EMPLOYER and the CONTRACTOR have agreed to enter into an agreement in terms of the provisions of Section 37(2) of the Occupational Health and Safety Act No 85 of 1993, as amended by the Occupational Health and Safety Amendment Act No 181 of 1993 (hereinafter referred to as the ACT);

NOW THEREFORE the parties agree as follows:

1. The CONTRACTOR undertakes to acquaint the appropriate officials and employees of the CONTRACTOR with all relevant provisions of the ACT and the regulations promulgated in terms thereof.
2. The CONTRACTOR undertakes to fully comply with all relevant duties, obligations and prohibitions imposed in terms of the ACT and Regulations: Provided that should the EMPLOYER have prescribed certain arrangements and procedures that same shall be observed and adhered to by the CONTRACTOR, his officials and employees. The CONTRACTOR shall bear the onus of acquainting himself/herself/itself with such arrangements and procedures.
3. The CONTRACTOR hereby accepts sole liability for such due compliance with the relevant duties, obligations, prohibitions, arrangements and procedures, if any, imposed by the ACT and Regulations, and the CONTRACTOR expressly absolves the EMPLOYER and the EMPLOYER'S AGENT from being obliged to comply with any of the aforesaid duties, obligations, prohibitions, arrangements and procedures in respect of the work included in the contract.
4. The CONTRACTOR agrees that any duly authorised officials of the EMPLOYER shall be entitled, although not obliged, to take such steps as may be necessary to ensure that the CONTRACTOR has complied with his undertakings as more fully set out in paragraphs 1 and 2 above, which steps may include, but shall not be limited to, the right to inspect any appropriate site or premises occupied by the CONTRACTOR, or to take such steps the EMPLOYER may deem necessary to remedy the default of the CONTRACTOR at the cost of the CONTRACTOR.

5. The CONTRACTOR shall be obliged to report forthwith to the EMPLOYER any investigation, complaint or criminal charge which may arise as a consequence of the provisions of the ACT and Regulations, pursuant to work performed in terms of this agreement, and shall, on written demand, provide full details in writing of such investigation, complaint or criminal charge.

Thus signed at for and on behalf of the **EMPLOYER**

on this the day of 20.....

SIGNATURE:

NAME AND SURNAME:

CAPACITY:

WITNESSES: 1.

2.

Thus signed at for and on behalf of the **CONTRACTOR**

on this the day of 20.....

SIGNATURE:

NAME AND SURNAME:

CAPACITY:

WITNESSES: 1.

2.

C1.5: RETENTION MONEY GUARANTEE

PRO FORMA

RETENTION MONEY GUARANTEE

THE HEAD: TRANSPORT
PROVINCE OF KWAZULU-NATAL
PRIVATE BAG X9043
PIETERMARITZBURG
3200

CONTRACT NO. _____ FOR _____

ISSUED TO: the **PROVINCE OF KWAZULU-NATAL**, represented by **HEAD: TRANSPORT** (hereinafter referred to as "the Employer")

ON BEHALF OF: (hereinafter referred to as "the Contractor")

In connection with

CONTRACT NO. ZNT (hereinafter referred to as "the Contract")

WHEREAS the Employer and the Contractor have agreed that the Contractor may provide a guarantee in lieu of the whole or portion of the retention monies provided for under the Contract;

NOW THEREFORE we, the undersigned, undertake, in accordance with the following provisions, to pay the Employer such amounts as the Employer may, from time to time, demand from us.

1. Each demand by the Employer shall be in writing signed by the Employer and delivered to us at

.....
or such other address as we shall in writing notify to the Employer and shall be accompanied by a certificate complying with Clause 2, signed by the Employer's Agent as such in terms of the Contract.

2. The Employer's Agent's certificate referred to in Clause 1 shall certify

- (a) that he is the Employer's Agent in terms of the Contract,
- (b) that the Contractor is in breach of his obligations under the Contract, and
- (c) that the amount demanded, which amount the certificate shall specify,

- (i) does not exceed the amount of retention monies which, but for this guarantee, would have been retained by the Employer in terms of the Contract at the date of the certificate, less the aggregate of the amounts of retention money actually retained by the Employer and the amounts previously paid by us to the Employer in terms hereof, and

- (ii) does not exceed a genuine estimate of the cost to the Employer of having the breach referred to in paragraph (b) remedied less the aggregate of any amounts withheld by the Employer from payments due the Contractor in terms of the Contract by reason of the breach referred to, and any amount in retention money actually held by the Employer save to the extent that the same had been deducted from any previous demand in terms hereof.

3. We shall within 28 days after our receipt of a demand complying with the provisions of Clauses 1 and 2 make payment to the Employer of the amount demanded at 172 Burger Street, Pietermaritzburg or at such other address as the Employer shall in writing notify us.

4. Subject to compliance with the provisions thereof, our liability to make the payments herein referred to shall be unconditional and shall not be affected nor diminished by any disputes, claims or counterclaims between the Employer and the Contractor.

5. Our aggregate liability under this guarantee is limited to R
6. This guarantee shall expire on the date on which the last of the retention monies, which but for this guarantee would have been retained by the Employer, becomes payable to the Contractor.
7. This guarantee is not transferable and must be produced for endorsement if any part payment is made and must be returned to us against final payment of our aggregate liability or on the date of the expiry of the guarantee in terms of Clause 6, whichever is the earlier.

Signed in the presence of the witnesses named hereunder:

At for and on behalf of

on this day of

Signature:

Capacity:

Address:

As Witnesses:

1. Name in Block Letters

2. Name in Block Letters

C1.6: TRANSFER OF RIGHTS

TRANSFER OF RIGHTS AND INDEMNITY

(To be completed during construction by successful Tenderer only)

Claim for Plant and materials on site, Payment Certificate No. Date:

Contract No: For (contract title)

I, the undersigned (name of signatory) in my capacity as
..... of (name of Contractor)

duly authorised hereto on behalf of the Contractor hereby transfer, cede and assign all the Contractor's rights, title and interest in and to the Plant and materials, for which evidence of bona fide ownership is attached hereto, unto and in favour of (name of Employer)

Insofar as the Contractor retains actual control of the materials and goods, the right of ownership thereof passes to the Employer by *constitutum possessorium*.

I herewith indemnify the Employer against any claim to and in respect of the said Plant and materials by reason of the Contractor's sequestration or liquidation or of any defect in the Contractor's title to the materials and agree that no payment for materials on site will be made by the Employer until such time as I have submitted documentary proof of bona fide ownership of the said Plant and materials.

This transfer shall become effective upon conclusion of the Contractor receiving payment from the Employer or from any other person on behalf of the Employer for the Plant and materials as Plant and materials on Site, payment of retention money thereon excluded.

I further confirm that I am fully responsible for all Plant and materials listed under this Transfer of Rights and that they have been insured adequately against all risks and will remain insured until they are built into or used in the permanent works and taken over by the Employer.

This certificate of Transfer of Rights applies only to the Plant and materials as listed in the following table.

DESCRIPTION OF ITEM	UNIT	QUANTITY	RATE	AMOUNT	SUPPLIER
TOTAL VALUE OF PLANT AND MATERIALS					

Signed by: **Date:**
for and on behalf of the Contractor.

Witnessed by:

NOTE: This form, together with the documentary proof of ownership or proof of payment by the Contractor to the supplier, shall accompany the Contractor's claim for payment for Plant and materials on site in terms of Clause 6.10.1.5 of the General Conditions of Contract 2015.

PART C2: PRICING DATA

C2.1 PRICING ASSUMPTIONS

1. GENERAL

The Bill of Quantities forms part of the Contract Documents and must be read and priced in conjunction with all the other documents comprising the Contract Documents, which include the Conditions of Tender, Conditions of Contract, the Specifications (including the Project Specifications) and the Drawings.

2. DESCRIPTION OF ITEMS IN THE SCHEDULE

The Bill of Quantities has been drawn up generally in accordance with the relevant provisions of the Standard Specifications for Road and Bridge Works for South African Road Authorities (COTO), Draft Standard (DS), October 2020.

The short descriptions of the items in the Bill of Quantities are for identification purposes only and the measurement and payment clause of the Standard Specifications for Road and Bridge Works for South African Road Authorities (COTO), Draft Standard (DS), October 2020. and the Particular Specifications, read together with the relevant clauses of the amendments and additions contained in the Project Specifications and directives on the drawings, set out what ancillary or associated work and activities are included in the rates for the operations specified.

The item numbers appearing in the Bill of Quantities refer to the corresponding item numbers in the Standard Specifications for Road and Bridge Works for South African Road Authorities (COTO), Draft Standard (DS), October 2020. Item numbers prefixed by the letter PS refer to items of payment described in Part B Amendments to the Standard Specifications.

For the purposes of this Bill of Quantities, the following words shall have the meanings hereby assigned to them:

Unit: The unit of measurement for each item of work as defined in the specifications.

Quantity: The number of units of work for each item.

Rate: The payment per unit of measurement at which the Tenderer tenders to do the work.

Amount: The product of the quantity and the rate tendered for an item.

Lump Sum: An amount tendered for an item, the extent of which is described in the Bill of Quantities, the specifications or elsewhere, but the quantity of work of which is not measured in any units.

3. QUANTITIES REFLECTED IN THE BILL OF QUANTITIES

The quantities given in the Bill of Quantities are estimates only, and are subject to re-measure during the execution of the work. The quantities finally accepted and certified for payment, and not the quantities given in the Bill of Quantities, shall be used to determine payments to the Contractor. The Contractor shall obtain the Employer's Agent's detailed instructions for all work before ordering any materials or executing work or making arrangements for it. The quantities of material or work stated in the Bill of Quantities shall not be regarded as authorisation for the Contractor to order material or to execute work.

The Works as finally completed in accordance with the Contract shall be measured and paid for as specified in the Bill of Quantities and in accordance with the Standard Specifications for Road and Bridge Works for South African Road Authorities (COTO), Draft Standard (DS), October 2020, the Project Specifications and the Drawings. Unless otherwise stated, items are measured net in accordance with the Drawings, and no allowance has been made for waste. The validity of the

contract will in no way be affected by differences between the quantities in the Bill of Quantities and the quantities finally certified for payment.

4. PROVISIONAL SUMS

Where Provisional sums or Prime Cost sums are provided for items in the Bill of Quantities, payment for the work done under such items will be made in accordance with Clause 6.6 of the General Conditions of Contract 2015. The Employer reserves the right, during the execution of the works, to adjust the stated amounts upwards or downwards according to the work actually done under the item, or the item may be omitted altogether, without affecting the validity of the Contract.

The Tenderer shall not under any circumstances whatsoever delete or amend any of the sums inserted by the Employer in the "Amount" column of the Bill of Quantities and in the Summary of the Bill of Quantities unless so ordered or authorised in writing by the Employer before closure of tenders. Any unauthorised changes made by the Tenderer to provisional items in the Bill of Quantities, or to the provisional percentages and sums in the Summary of the Bill of Quantities, at the Employer's discretion, may invalidate the Tenderer's offer or may be treated as arithmetical errors and the provisional items and percentages corrected without change to the Contract Sum.

5. PRICING OF THE BILL OF QUANTITIES

The prices and rates to be inserted by the Tenderer in the Bill of Quantities shall be the full inclusive prices to be paid by the Employer for the work described under the several items, and shall include full compensation for all costs and expenses that may be required in and for the completion and maintenance during the defects liability period of all the work described and as shown on the drawings as well as all overheads, profits, incidentals and the cost of all general risks, liabilities and obligations set forth or implied in the documents on which the Tender is based. The rates and lump sums shall be comprehensive in accordance with Standard Specifications for Road and Bridge Works for South African Road Authorities (COTO), Draft Standard (DS), October 2020.

Each item shall be priced and extended to the "Amount" column by the Tenderer, with the exception of the items for which only rates are required, or items which already have Prime Cost or Provisional Sums affixed thereto. If the Tenderer omits to price any items in the Bill of Quantities, then these items will be considered to have a nil rate or price.

All items for which terminology such as "inclusive" or "not applicable" have been added by the Tenderer will be regarded as having a nil rate which shall be valid irrespective of any change in quantities during the execution of the Contract.

Should the Tenderer group a number of items together and tender one lump sum for such group of items, this single lump sum shall apply to that group of items and not to each individual item.

The tendered lump sums and rates shall be valid irrespective of any change in the quantities during the execution of the contract.

The Tenderer shall fill in rates for all items where the words "rate only" appear in the "Amount" column. The provisions of subclause C1.1.3.6 of the Standard Specifications for Road and Bridge Works for South African Road Authorities (COTO), Draft Standard (DS), October 2020 shall apply to rate only items. "Rate Only" items have been included where:

- (a) an alternative item or material is contemplated;
- (b) variations of specified components in the make-up of a pay item may be expected; and
- (c) no work under the item is foreseen at tender stage but the possibility that such work may be required is not excluded.

For "Rate Only" items, no quantities are given in the "Quantity" column but the quoted rate shall apply in the event of work under this item being required. The Tenderer shall, however, note that in terms of the Tender Data the Tenderer may be asked to reconsider any such rates which the Employer may regard as imbalanced.

Reasonable compensation will be received where no pay item appears in respect of work required in terms of the Contract which is not covered in any other pay item.

All rates and amounts quoted in the Bill of Quantities shall be in Rands and cents and shall include all levies and taxes (other than VAT). VAT will be added in the summary of the Bill of Quantities. Note that fractions of a cent in all rates shall be omitted.

6. CORRECTION OF ENTRIES

Incorrect entries shall not be erased or obliterated with correction fluid but must be crossed out neatly. The correct figures must be entered above or adjacent to the deleted entry, and the alteration must be initialled by the Tenderer.

7. INTERIM PAYMENTS

Unless otherwise specified, progress payments in Interim Certificates, referred to in Clause 6.10 of the General Conditions of Contract 2015, in respect of "sum" items in the Bill of Quantities shall be by means of interim progress instalments assessed by the Employer's Agent and based on the measure in which the work actually carried out relates to the extent of the work to be executed by the Contractor.

Notwithstanding any custom to the contrary, the work as executed will be measured for payment in accordance with the methods described in the contract documents under the various items of payment.

Attention is directed to the provisions of Clause C1.1.2 of the Standard Specifications for Road and Bridge Works for South African Road Authorities (COTO), Draft Standard (DS), October 2020 regarding the measurement of quantities for payment. Except where specified otherwise, the nett measurements or mass of the finished work in place shall be taken for payment, but any quantity of work in excess of that prescribed shall be excluded.

8. ITEMS SCHEDULED FOR CONSTRUCTION USING LABOUR ENHANCED METHODS

Those parts of the Works to be constructed using labour enhanced methods are numbered with the specific COTO, Draft Standard (DS), October 2020 Specifications items in the Bill of Quantities.

9. UNITS OF MEASUREMENT

The units of measurement described in the Bill of Quantities are metric units. The following abbreviations are used in the Bill of Quantities:

mm	= millimetre	m ³ .km	= cubic metre kilometre	Prov sum	= provisional sum
m	= metre	l	= litre	kPa	= kilopascal
km	= kilometre	kl	= kilolitre	MPa	= megapascal
km.pass	= kilometre pass	kg	= kilogram	MN	= meganewton
m ²	= square metre	t	= ton (1 000 kg)	t.km	= ton kilometre
m ² .pass	= square metre pass	No	= number	h	= hour
ha	= hectare	%	= percent	dia	= diameter
m ³	= cubic metre	PC sum	= prime cost sum	Sum	= lump sum
kW	= kilowatt	MN.m	= meganewton metre		

10. CONSISTENCY OF RATES

In order to ensure that payments certified by the Employer's Agent are reasonably consistent with the market value of the work done, and that variations in quantities do not distort the contract valuation, the rates, prices and amounts tendered in the Bill of Quantities are required to be in balance.

A tender will be considered out of balance if:

- (i) the combined, extended total tendered for the item:

C1.3.1 The contractor's general obligations:

- C1.3.1.1 Fixed obligations
- C1.3.1.2 Value-related obligations
- C1.3.1.3 Time-related obligations

exceeds a maximum of 15% of the Contract Sum (excluding contingencies, contract price adjustment and VAT).

- (ii) the rate, price or amount tendered for any other item differs by more than 20 (twenty) percent from the average of the rates, prices or amounts for the same item as tendered by those tenderers who submitted the lowest five responsive tender offers (or as tendered by all the responsive tenderers if there are less than five responsive tenderers).

Any such out of balance tender may be rejected if, after three (3) working days of having been given written notice by the Employer to adjust those rates or lump sums which are unreasonable or out of balance, the Tenderer fails to make the necessary satisfactory adjustments. These adjustments in rectification will be such that increases are balanced by decreases, leaving the tender offer unchanged.

C2.2 BILL OF QUANTITIES

<u>TABLE OF CONTENTS</u>	Page
BILL OF QUANTITIES	C29
TENDER SUMMARY	C41

**BETTERMENT AND REGRAVELLING OF P708 KM 0.8 TO KM 4.3
ZNB0068/00000/00/ESH/INF/21/T**

SCHEDULE A: ROADWORKS

CHAPTER C1.2

ITEM	DESCRIPTION	LI	UNIT	QTY	RATE	AMOUNT R
C1.2	GENERAL REQUIREMENTS AND PAYMENT					
C1.2.2.6.1	Submission of Scheme 1 Programme		Lump Sum	1		
C1.2.2.6.2	Reviewing and Updating Scheme 1 Programme		Month	3		
C1.2.2.6.3	Preparation and Submission of all information and reports specified in the contract documentation		Month	3		
C1.2.5	Safety					
C1.2.5.1	Health and safety plan		Lump Sum	1		
C1.2.5.2	Implementation of health and safety plan		month	3		
TOTAL CARRIED FORWARD TO SUMMARY (Page C41)						

**BETTERMENT AND REGRAVELLING OF P708 FROM KM 0.8 TO KM 4.3
ZNB0068/00000/00/ESH/INF/21/T**

SCHEDULE A: ROADWORKS

CHAPTER C1.3

ITEM	DESCRIPTION	LI	UNIT	QTY	RATE	AMOUNT R
C1.3	CONTRACTOR'S SITE ESTABLISHMENT AND GENERAL OBLIGATIONS					
C1.3.1	The Contractor's general obligations					
C1.3.1.1	Fixed obligations		Lump Sum	1		
C1.3.1.2	Value-related obligations		Lump Sum	1		
C1.3.1.3	Time-related obligations		month	3		
C1.3.2	Contract sign boards	LI	m2	11.75		
TOTAL CARRIED FORWARD TO SUMMARY (Page C41)						

**BETTERMENT AND REGRAVELLING OF P708 FROM KM 0.8 TO KM 4.3
ZNB0068/00000/00/ESH/INF/21/T**

SCHEDULE A: ROADWORKS

CHAPTER C1.5

ITEM	DESCRIPTION	LI	UNIT	QTY	RATE	AMOUNT R
C1.5	ACCOMMODATION OF TRAFFIC					
C1.5.7.3	Flagmen	LI	man-shift	132		
C1.5.7.5	Provision of illuminated traffic signs					
	Sign mounted flashing amber lights (2 lights with the specified power supply) mounted on a backing board which is:					
(a)						
(a.i)	900 mm wide x 150mm high		No	2		
(a.ii)	1200 mm wide x 200 mm high		No	2		
TOTAL CARRIED FORWARD TO SUMMARY (Page C41)						

**BETTERMENT AND REGRAVELLING OF P708 FROM KM 0.8 TO KM 4.3
ZNB0068/00000/00/ESH/INF/21/T**

SCHEDULE A: ROADWORKS

CHAPTER C1.5

ITEM	DESCRIPTION	LI	UNIT	QTY	RATE	AMOUNT R
C1.5.4	Construction of temporary deviations					
C1.5.4/1.7.2	Hauling material for use in the Works and off-loading it on the site of the Works		m ³ -km	360		
C1.5.4/C3.2.1.1	Excavation in all material situated within the following depth ranges below the surface level:					
(a)	0m to 1.5m		m ³	6		
C1.5.4/C3.2.2	Backfilling					
C1.5.4/C3.2.2.1	Using the excavated material:					
C1.5.4/C3.2.3	Concrete pipe culverts:					
C1.5.4/C3.2.3.3	On Class C bedding (600mm diameter Class 75D OGEE with Rubber Collars)					
	a) 600mm dia. Ogee Class 75D with Rubber Collars		m	7.5		
C1.5.4/C5.1.1.2	Compaction of in-situ material to 93% of MDD		m ³	90		
C1.5.4/C5.1.4.1	In layer thicknesses of 200mm and less		m ³	10		
(g)	Gravel wearing course layer (layer thickness indicated) compacted to 95% of MDD		m ³	90		
TOTAL CARRIED FORWARD TO SUMMARY (Page C41)						

**BETTERMENT AND REGRAVELLING OF P708 FROM KM 0.8 TO KM 4.3
ZNB0068/00000/00/ESH/INF/21/T**

SCHEDULE A: ROADWORKS

CHAPTER C1.7

ITEM	DESCRIPTION	LI	UNIT	QTY	RATE	AMOUNT R
C1.7	LOADING AND HAULING					
C1.7.2	Hauling					
C1.7.2.1	Hauling material for use in the Works and off-loading it on the site of the Works:		m3. km	12443		
TOTAL CARRIED FORWARD TO SUMMARY (Page C41)						

**BETTERMENT AND REGRAVELLING OF P708 FROM KM 0.8 TO KM 4.3
ZNB0068/00000/00/ESH/INF/21/T**

CHAPTER C3.1

ITEM	DESCRIPTION	LI	UNIT	QTY	RATE	AMOUNT R
C3.1	DRAINS					
C3.1.1	Excavation for open drains:					
C3.1.1.1	Excavating all material situated within the following depth ranges below the surface level using conventional methods :					
(a)	0m to 1.5m	LI	m3	50		
C3.1.3	Excavation, clearing and disposal of accumulated sediment in existing lined drains and drainage systems					
C3.1.3.1	Using conventional methods (up to 1.5m) :					
(a)	Manhole and inlet and outlet structures	LI	m3	5		
(b)	Culvert barrels	LI	m3	5		
TOTAL CARRIED FORWARD TO SUMMARY (Page C41)						

**BETTERMENT AND REGRAVELLING OF P708 FROM KM 0.8 TO KM 4.3
ZNB0068/00000/00/ESH/INF/21/T**

SCHEDULE A: ROADWORKS

CHAPTER C3.2

ITEM	DESCRIPTION	LI	UNIT	QTY	RATE	AMOUNT R
C3.2	CULVERTS					
C3.2.1	Excavation for culvert structures:					
C3.2.1.1	Excavating in all material situated within the following depth ranges below the surface level:					
(a)	0m to 1.5m	LI	m3	100		
C3.2.2	Backfilling:					
C3.2.2.1	Using the excavated material	LI	m3	80		
C3.2.3	Concrete pipe culverts:					
C3.2.3.3	On Class C bedding (600mm diameter Class 75D OGEE with Rubber Collars) a) 600mm dia. Ogee Class 75D with Rubber Collars	LI	m	37,5		
C3.2.3.3	On Class C bedding (900mm diameter Class 75D OGEE with Rubber Collars) a) 900mm dia. Ogee Class 75D with Rubber Collars	LI	m	15		
C3.2.7.5	In inlet and outlet structures including kerbs, chutes and downpipes, skewed ends, catchpits, manholes, thrust and anchor blocks, excluding formwork but including Class U2 surfacing finish (class 25/19 Concrete)	LI	m3	65		
TOTAL CARRIED FORWARD TO SUMMARY (Page C41)						

**BETTERMENT AND REGRAVELLING OF P708 FROM KM 0.8 TO KM 4.3
ZNB0068/00000/00/ESH/INF/21/T**

SCHEDULE A: ROADWORKS

CHAPTER C3.3

ITEM	DESCRIPTION	LI	UNIT	QTY	RATE	AMOUNT R
C3.3	CONCRETE KERBING AND CHANNELING, ASPHALT BERMS, CHUTES, DOWNPIPES, AS WELL AS CONCRETE, STONE PITCHED AND GABION LININGS FOR OPEN DRAINS					
C3.3.8.3 (a)	<u>Stone pitched lining (200 mm thickness)</u> Grouted stone pitching (type of open drain indicated)	LI	m2	100		
TOTAL CARRIED FORWARD TO SUMMARY (Page C41)						

**BETTERMENT AND REGRAVELLING OF P708 FROM KM 0.8 TO KM 4.3
ZNB0068/00000/00/ESH/INF/21/T**

SCHEDULE A: ROADWORKS

CHAPTER C4.1

ITEM	DESCRIPTION	LI	UNIT	QTY	RATE	AMOUNT R
C4.1	BORROW MATERIALS					
C4.1.5	Excavating of materials in the borrow pits and quarries, material obtained from					
C4.1.5.1	Soft excavation		m ³	5095,5		
C4.1.15	Shaping and finishing the borrow pit and quarry areas, and the stockpile sites					
C4.1.15.1	Shaping and finishing the borrow pit and quarry areas, and the stockpile sites:					
(a)	Borrow pits		ha	0.5		
TOTAL CARRIED FORWARD TO SUMMARY (Page C41)						

**BETTERMENT AND REGRAVELLING OF P708 FROM KM 0.8 TO KM 4.3
ZNB0068/00000/00/ESH/INF/21/T**

SCHEDULE A: ROADWORKS

CHAPTER C5.1

ITEM	DESCRIPTION	LI	UNIT	QTY	RATE	AMOUNT R
C5.1	ROADBED					
C5.1.1.2	Compaction of in-situ material to 93% of MDD		m3	4200		
C5.1.4	Removal of unsuitable material to spoil					
C5.1.4.1	In layer thicknesses of 200mm and less		m3	112,5		
TOTAL CARRIED FORWARD TO SUMMARY (Page C41)						

**BETTERMENT AND REGRAVELLING OF P708 FROM KM 0.8 TO KM 4.3
ZNB0068/00000/00/ESH/INF/21/T**

SCHEDULE A: ROADWORKS

CHAPTER C5.3

ITEM	DESCRIPTION	LI	UNIT	QTY	RATE	AMOUNT R
C5.3	ROAD PAVEMENT LAYERS					
(g)	Gravel wearing course layer (layer thickness indicated) compacted to 95% of MDD		m ³	4147.5		
TOTAL CARRIED FORWARD TO SUMMARY (Page C41)						

**BETTERMENT AND REGRAVELLING OF P708 FROM KM 0.8 TO KM 4.3
ZNB0068/00000/00/ESH/INF/21/T**

SCHEDULE A: ROADWORKS

CHAPTER C11.9

ITEM	DESCRIPTION	LI	UNIT	QTY	RATE	AMOUNT R
C11.9	FINISHING THE ROAD AND ROAD RESERVE AND TREATING OLD ROADS					
C11.9.1	Finishing the road and road reserve:					
C11.9.1.2	Single carriageway road		km	3.5		
TOTAL CARRIED FORWARD TO SUMMARY (Page C41)						

**PROVINCE OF KWAZULU-NATAL
DEPARTMENT OF TRANSPORT**

**CONTRACT NO. ZNB0068/00000/00/ESH/INF/21/T:
BETTERMENT AND REGRAVELLING OF P708 FROM KM 0.8 TO KM 4.3**

SCHEDULE A: ROADWORKS

SUMMARY OF SECTIONS

CHAPTER	DESCRIPTION	FROM PAGE	AMOUNT
C1.2	GENERAL REQUIREMENTS AND PAYMENT	C29	R
C1.3	CONTRACTOR'S SITE ESTABLISHMENT AND GENERAL OBLIGATIONS	C30	R
C1.5	ACCOMMODATION OF TRAFFIC	C31	R
C1.7	LOADING AND HAULING	C33	R
C3.1	DRAINS	C34	R
C3.2	CULVERTS	C35	R
C3.3	CONCRETE KERBING AND CHANNELING, ASPHALT BERMS, CHUTES, DOWNPIPES, AS WELL AS CONCRETE, STONE PITCHED AND GABION LININGS FOR OPEN DRAINS	C36	R
C4.1	BORROW MATERIALS	C37	R
C5.1	ROADBED	C38	R
C5.3	ROAD PAVEMENT LAYERS	C39	R
C11.9	FINISHING THE ROAD AND ROAD RESERVE AND TREATING OLD ROADS	C40	R
	TOTAL CARRIED FORWARD TO TENDER SUMMARY (Page C42)	C42	R

**PROVINCE OF KWAZULU-NATAL
DEPARTMENT OF TRANSPORT**

**CONTRACT NO. ZNB0068/00000/00/ESH/INF/21/T: BETTERMENT AND REGRAVELLING OF P708
FROM KM 0.8 TO KM 4.3 IN THE EMPANGENI REGION**

TENDER SUMMARY

DESCRIPTION	AMOUNT
Totals of Bill of Quantities brought forward:	
Schedule A: Roadworks (b/f from page C40)	R
	R
	R
	R
	R
	R
SUBTOTAL 1	R
<u>Add:</u> Contingencies (5% of SUBTOTAL 1)	R
SUBTOTAL 2	R
<u>Add:</u> Contract Price Adjustment (5% of SUBTOTAL 2)	R
SUBTOTAL 3	R
<u>Add:</u> VAT (15% of SUBTOTAL 3)	R
TOTAL CARRIED FORWARD TO FORM OF OFFER C1.1.1	R

Signed on behalf of the Tenderer: (Signature)

Date:

Tenderer's Name: (Company Name)

PART C3: SCOPE OF WORK

<u>TABLE OF CONTENTS</u>	PAGE
C3.1 STANDARD SPECIFICATIONS	C43
C3.2 PROJECT SPECIFICATIONS	C43
PART A: GENERAL	
1. DESCRIPTION OF THE WORKS	C44
2. DRAWINGS.....	C49
3. PROCUREMENT	C49
4. CONSTRUCTION	C49
5. MANAGEMENT.....	C50
PART B: AMENDMENTS TO THE STANDARD SPECIFICATIONS	
PROJECT SPECIFICATIONS RELATING TO THE STANDARD SPECIFICATIONS AND OTHER ADDITIONAL SPECIFICATIONS	C53
C3.3 PARTICULAR SPECIFICATIONS	
PART C: ENVIRONMENTAL MANAGEMENT SPECIFICATION.....	C59
PART D: OHSA 1993 HEALTH AND SAFETY SPECIFICATION	C65
PART E: EXPANDED PUBLIC WORKS PROGRAMME.....	C69
PART F: SMALL CONTRACTOR DEVELOPMENT.....	C77

C3.1: STANDARD SPECIFICATIONS

The Standard Specifications on which this contract is based are the '**Standard Specifications for Road and Bridge Works for South African Road Authorities (COTO), Draft Standard (DS), October 2020**'.

C3.2: PROJECT SPECIFICATIONS

The Project Specifications, consisting of two parts, form an integral part of the Contract and supplement the Standard Specifications.

Part A contains a general description of the Works, the Site and the requirements to be met.

Part B contains variations, amendments and additions to the Standard Specifications and, if applicable, the Particular Specifications.

In the event of any discrepancy between a part or parts of the Standard or Particular Specifications and the Project Specifications, the Project Specifications shall take precedence. In the event of a discrepancy between the Specifications (including the Project Specifications) and the drawings and / or the Bill of Quantities, the discrepancy shall be resolved by the Employer's Agent before the execution of the work under the relevant item.

The Standard Specifications, which form part of this contract, have been written to cover all phases of work normally required for road contracts, and they may therefore cover items not applicable to this particular contract.

C3.2: PROJECT SPECIFICATIONS

PART A: GENERAL

1. DESCRIPTION OF THE WORKS

1.1 Employer's objectives

This Project forms part of the Province of KwaZulu-Natal Department of Transport's upgrade of existing gravel roads and drainage improvement for the purpose of generating employment to surrounding areas.

The contract is located in a region of KwaZulu-Natal that has been historically impoverished by a lack of infrastructure access. It is therefore mandatory that the Contractor shall interact with the community via proactive project liaison with and project participation by its leaders and constituted organisations and forums, as well as through the employment of its people, and these activities shall constitute essential facets of the project.

The Employer's objectives in delivering public infrastructure and services for this project include the provision of temporary work opportunities to the local community through the application of labour-intensive methods to the maximum extent feasible, in accordance with the Expanded Public Works Programme Guidelines.

The Contractor shall be required to attend meetings of the local Project Liaison Committee (PLC) from time to time. The requirements of the Expanded Public Works Programme (EPWP) are contained in Part F of section C3.3 Particular Specifications. These EPWP requirements also include provisions for the National Youth Service programme where applicable. The requirements in terms of Government's initiatives for broad-based black economic empowerment with respect to small contractor development are contained in Part G of section C3.3 Particular Specifications.

1.2 Location of the Works

The road is located within the Mfolozi Local Municipality, of the Main Road P47-4.

1.3 Overview of the Works

The project comprises the betterment and re-gravelling of two (2) kilometres of the P494. It will include reshaping and layer works with the associated road prism drainage.

1.4 Extent of the Works

The Works to be carried out include the following main activities:

- a) Establishment
- b) Accommodation of traffic
- c) Betterment and re-gravelling
- d) Drainage Improvements
- e) Stone-pitching
- f) Drop Inlet and Headwall construction
- g) Finishing-off borrow areas

1.5 Detailed description of the Works

The following description is a broad outline of the works and does not limit the work to be executed by the Contractor in terms of the contract. The description of some of the major items indicated in this section are indicative, not absolute, and are provided to define in general terms the overall scope of the project.

No approximate quantities of each type of work to be carried out in accordance with the contract documents are listed in the Schedule of Quantities on the following tables.

The site shall not only comprise the proclaimed road reserve but shall be extended in the broader sense to

take account of all areas occupied by the Contractor, be it deliberate or unintentional, in the execution of the contract. The site includes all the land within the proclaimed limits of the road reserve along the extent of the works, borrow pits and quarry sites, stockpile areas, locations set aside for construction and supervision accommodation and any other location required for the execution of the Works.

Incidental intrusion into private or tribal property outside the road reserve shall not be permitted without the owner's written authority. Any such agreement reached with a private or tribal landowner (occupier) shall include the proviso that any material or equipment on that site shall remain the exclusive property of the Employer in terms of the contract.

1.5.1 Access to the Site

Please refer to the Locality Map (C4.1).

The road is located within the Mfolozi Local Municipality, of the Main Road P47-4.

1.5.2 Demolition work

The Contractor is not required to carry out any demolition work to existing structures.

1.5.3 Spoiling of surplus material

Surplus material shall be spoiled in designated areas approved by the Employer's Agent. The spoil material shall be disposed of in accordance with subclause A4.1.7.2(l) of the COTO Standard Specifications.

1.5.4 Quantities

The approximate leading quantities for the permanent Works to be constructed will be issued as per respective roads to be identified by Project Managers.

1.5.5 Material investigations

Materials information is furnished in section C4.4 at the end of this document.

1.5.6 Material sources, spoil and stockpile areas

The G7 material for the gravel wearing course shall be obtained from the borrow pit nearest to the road, located approximately 12.20 km from the access to site.

Spoil areas and areas for the temporary stockpiling of construction materials shall be determined and agreed on site in conjunction with the Employer's Agent and the local communities (where applicable). The Service Provider shall be permitted to use only these agreed spoil and stockpile areas, which shall be landscaped and vegetated on completion of the work.

1.5.8 Accommodation of other contractors

Other contractors working on the site shall include:

In order to ensure the smooth running of all contracts, the Contractor shall be required to liaise with, cooperate with and accommodate all other contractors working on the site, particularly when such other contractors are working in the same area simultaneously.

1.5.9 Existing services

It is expected that unknown domestic services crossings requiring relocation or protection may be encountered along the route as the work proceeds. The Contractor shall make every effort to establish the location of these services in any area prior to excavations commencing in that area. Such efforts shall include diligent enquiry and discussions with adjacent landowners, visual surface inspection and exploratory trenching investigation as necessary.

1.5.10 Employer's Agent's site offices and laboratory

The Contractor shall be required to provide furnished site office facilities, laboratory facilities, ablution facilities, and carpports for the Employer's Agent at a site located in close proximity to the Contractor's office establishment and to the Works. A possible area for such site establishment shall be indicated at the Site Clarification Meeting.

1.5.11 Climate

The road is located in a high summer rainfall region with a mean annual precipitation of 838 mm.

1.5.12 Environment

The Contractor's attention is called to clause A1.2.3.3 of Standard Specifications for Road and Bridge Works for South African Road Authorities (COTO), Draft Standard (DS), October 2020 and to the requirements of Part C: Environmental Management Specification contained in section C3.3 Particular Specifications.

1.5.13 Labour

A Project Liaison Committee (PLC) is not applicable on this document.

1.8 Testing of materials

The Contractor shall carry out at his own cost the required process control testing as specified in terms of the Standard Specifications for Road and Bridge Works for South African Road Authorities (COTO), Draft Standard (DS), October 2020.

1.9 Power supply and other services

The Contractor shall make his own arrangements concerning the supply of electrical power and all other services. No direct payment shall be made for the provision of electrical and other services. The cost thereof shall be deemed to be included in the rates and amounts tendered for the various items of work for which these services are required.

1.10 Construction in confined areas

It may be necessary for the Contractor to work within confined areas. Except where provided for in the specifications, no additional payment shall be made for work done in restricted areas. In certain places the width of the fill material and pavement layers may decrease to zero and the working space may be confined. The method of construction in these confined areas largely depends on the Contractor's constructional plant. However, the Contractor shall note that, unless otherwise provided for in terms of the scheduled payment items in the Standard Specifications for Road and Bridge Works for South African Road Authorities (COTO), Draft Standard (DS), October 2020 or these project specifications, measurement and payment shall be in accordance with the specified cross sections and dimensions only, irrespective of the method used for achieving these cross sections and dimensions, and that the tendered rates and amounts shall include full compensation for all special equipment and construction methods and for all difficulties encountered when working in confined areas and narrow widths, and at or around obstructions, and that no extra payment shall be made nor shall any claim for additional payment be considered in such cases.

1.11 Contractor's campsite (Project Specific)

Possible locations for a campsite shall be pointed out at the clarification meeting. (Project Specific Clarification meetings)

The Contractor shall make his own arrangements for the provision of his campsite and housing for construction personnel but the chosen site shall be subject to the approval of the Employer's Agent, the local authorities and, where applicable, the Project Liaison Committee (PLC) associated with the project.

The standard of the Contractor's camp, offices, accommodation, ablution, and other facilities must comply with the requirements of all local authority, environmental and industrial regulations concerned. In establishing and maintaining his campsite, due cognisance is to be taken of the requirements of clause A1.3.3 of the

Standard Specifications for Road and Bridge Works for South African Road Authorities (COTO), Draft Standard (DS), October 2020.

The Contractor is to fully familiarise himself with all local by-laws and Government regulations for the employment, transport and accommodation of labour on site.

The Contractor shall particularly note that there is a high risk of theft, vandalism and damage to property in this area and strict security will be required for all plant, establishment, temporary works and partially completed works. The Contractor shall be responsible for providing security for all plant, establishment, temporary works and partially completed works. No separate payment shall be made for the provision of such security since full compensation for these costs shall be deemed to be included in the amount tendered for item C1.3.1.3 (The contractor's general obligations: Time-related obligations).

1.12 Additional requirements for construction activities

The travelling public shall have the right of way on public roads, and the Contractor shall make use of approved methods to control the movement of his equipment and vehicles so as not to constitute a hazard on the road.

The Contractor's tendered rates shall include full compensation for all costs which may arise from the construction and maintenance of deviations and construction under traffic. No claim for additional costs which may arise from these methods of traffic accommodation and no additional payment owing to inconvenience as a result of the Contractor's method of working shall be considered.

1.13 Construction programme

The Contractor shall submit a detailed time programme in accordance with clause 5.6.2 of the General Conditions of Contract 2015, clause A1.2.7 of the Standard Specifications for Road and Bridge Works for South African Road Authorities (COTO), Draft Standard (DS), October 2020.

In addition to any other restrictions accommodated by the Contractor in compiling the construction programme, the following constraints shall be taken into account in the preparation thereof:

- (a) The whole of the Works (and the portions of the Works if completion in portions is required) shall be completed within the time period(s) stated (refer to the Contract Data in section C1.2.2).
- (b) Working days lost due to abnormal rainfall shall be treated as set out in clause A1.2.3.4 (b)
- (c) Allowance shall be made for non-working days and special non-working days (refer to the Contract Data in section C1.2.2).
- (d) Construction activities must comply with all the specified environmental requirements including clause A1.2.3.3 of Standard Specifications for Road and Bridge Works for South African Road Authorities (COTO), Draft Standard (DS), October 2020 and the requirements of Part C: Environmental Management Specification contained in section C3.3 Particular Specifications.
- (e) Construction activities must comply with all the specified health and safety obligations including the requirements of Part D: OHS 1993 Health and Safety Specification contained in section C3.3 Particular Specifications.
- (f) Strict control of access to and from local public roads shall be required when construction vehicles, plant or equipment leave or enter the site.
- (g) Throughout the contract period traffic must be accommodated through the site and all other contractors engaged on the construction of identified roads must be accommodated.
- (h) The Contractor's programme of work shall take due cognisance of risks by limiting the duration of the exposure of the various construction elements to natural phenomena.

PRELIMINARY CONSTRUCTION PROGRAMME

Compiler to insert the Preliminary Construction Programme

2. DRAWINGS

The drawings that form part of the Tender documents are issued on a CD and shall be used for Tender purposes only.

The Contractor will be supplied with three complete sets of A0 paper print drawings, and one set of drawings on a CD. These A0 paper prints and CD are issued free of charge and the Contractor shall make any additional copies he may require at his own cost.

Any information in the possession of the Contractor which the Employer's Agent requires to complete the as-built drawings shall be supplied to the Employer's Agent before a certificate of completion will be issued.

Only figured dimensions shall be used and drawings shall not be scaled unless so instructed by the Employer's Agent. The Employer's Agent will supply all figures / dimensions omitted from the drawings.

The levels given on the drawings are subject to confirmation on site, and the Contractor shall submit all levels to the Employer's Agent for confirmation before he commences any structural construction work. The Contractor shall also check all clearances given on the drawings and shall inform the Employer's Agent of any discrepancies.

DRAWINGS

DWG NO.	DESCRIPTION
	STANDARD DETAILS
SD 0209/B	Type 5 Secondary/ Tertiary Gravel Road
SD 0401/B	Concrete Pipe Culvert Bedding
SD 0405/A	Depressed Inlet
SD 0406	Pipe Culvert Headwall (Masonry)

Traffic Accommodation Signposting

Mitre Drains and Drifts

Bolster Details

Form D: Tally Sheet for Gravel Haul

Spacing Loads for Varying Road Widths and Layer Thicknesses

TYPE 5 Secondary/ Tertiary Gravel Road

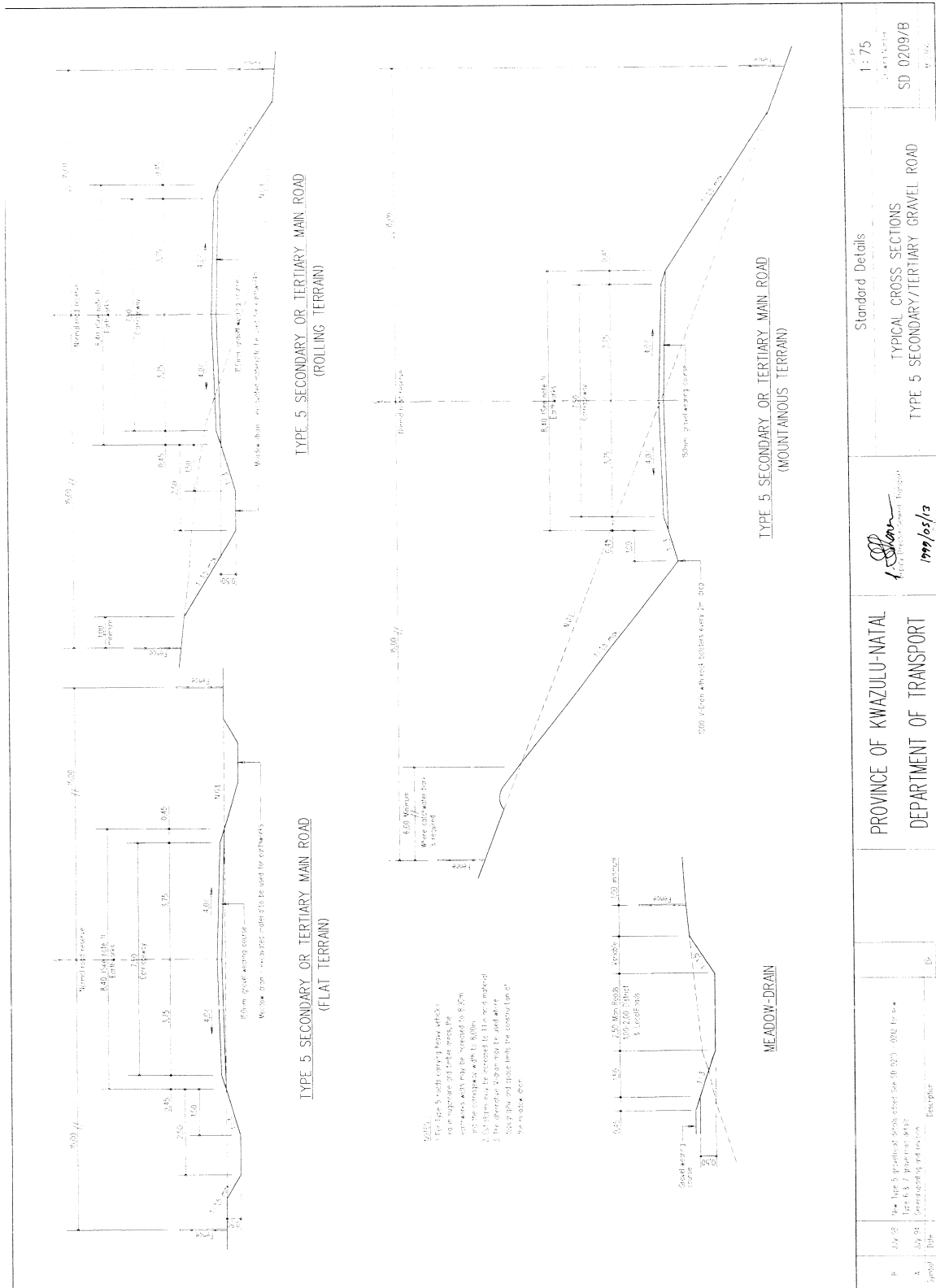

Signposting for Work Carried Out Under Traffic

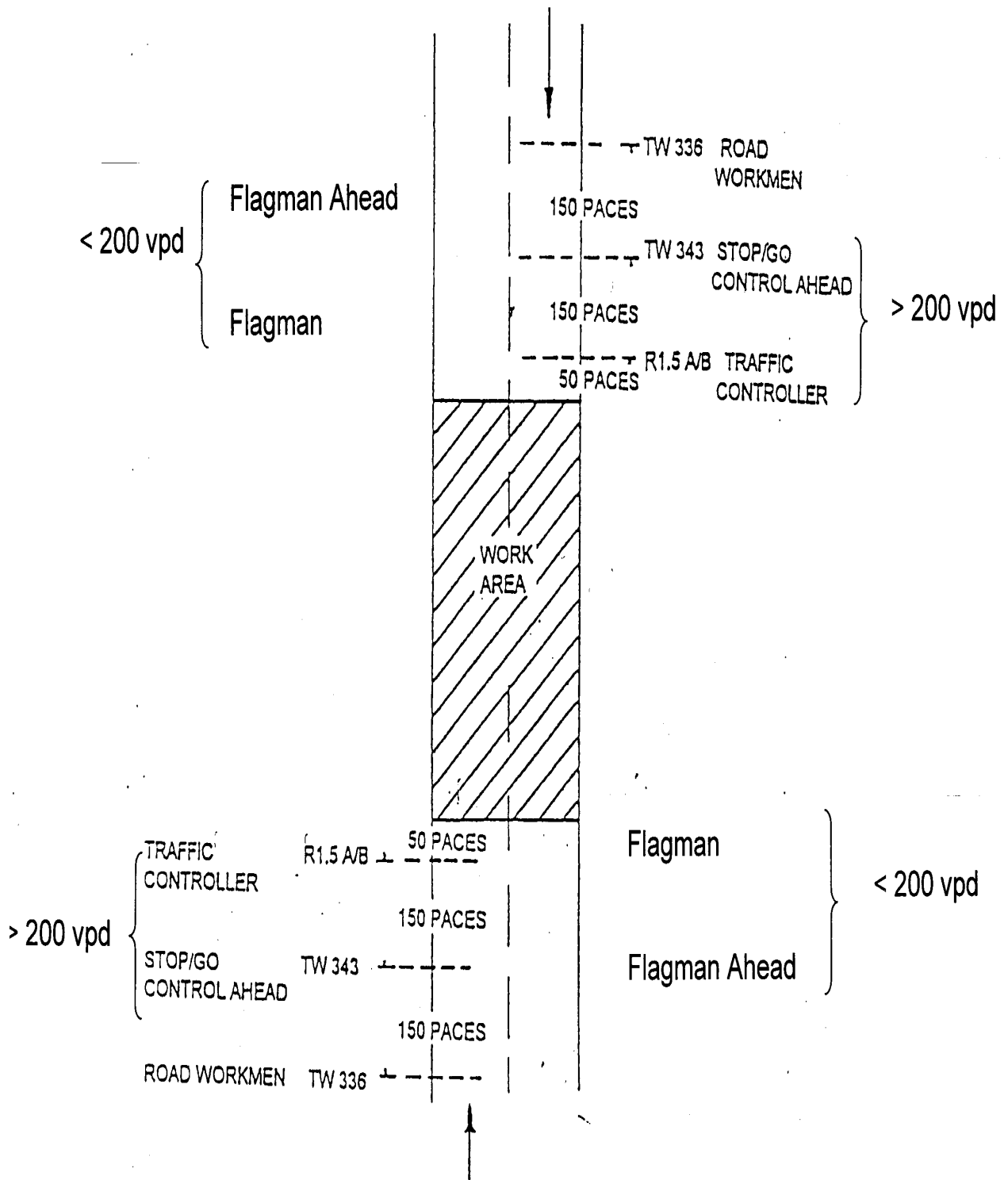

Mitre Drains & Drifts

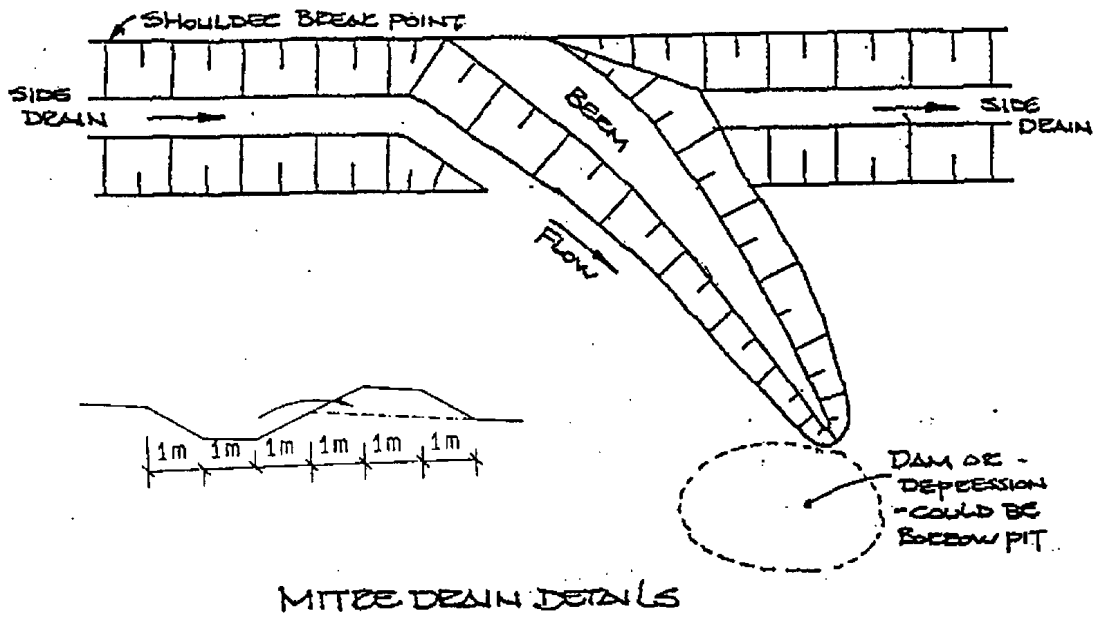

DRIFTS FOR LONGITUDINAL SLOPES

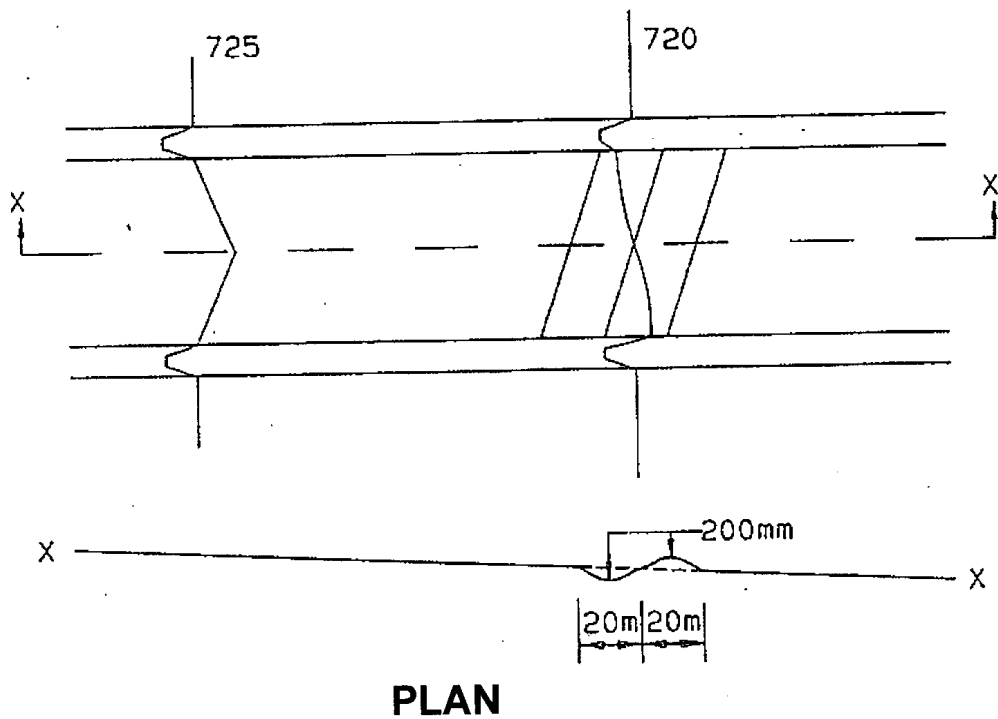

Bolster Details

TYPICAL SCOUR CHECK DETAILS

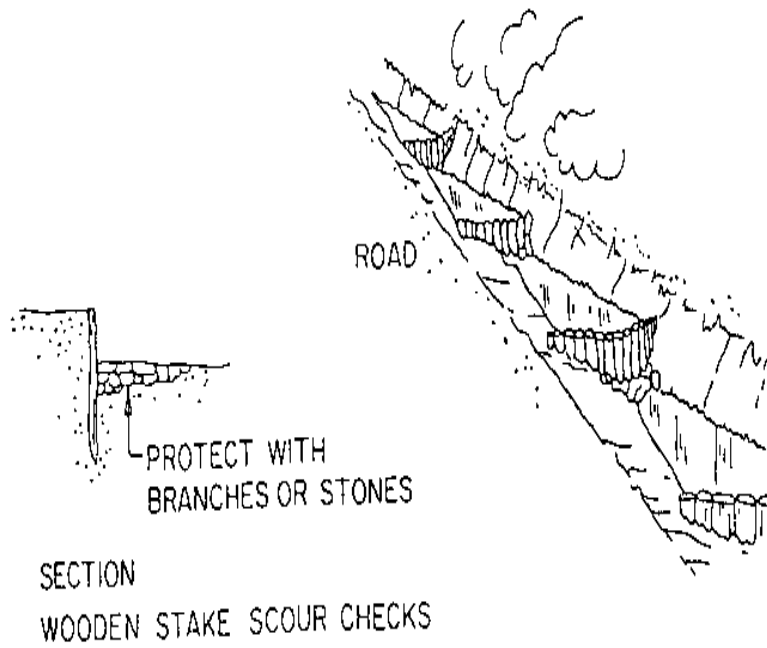
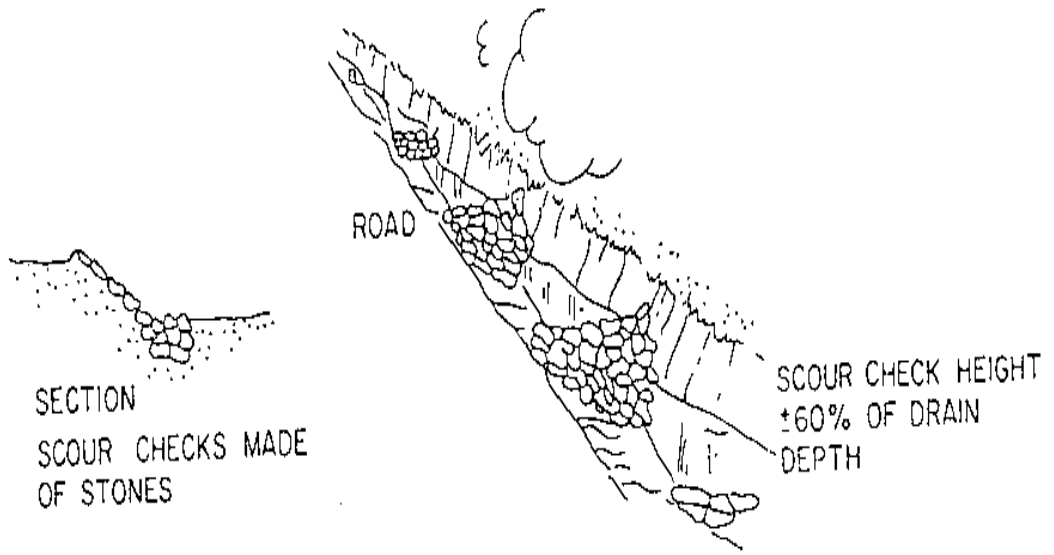

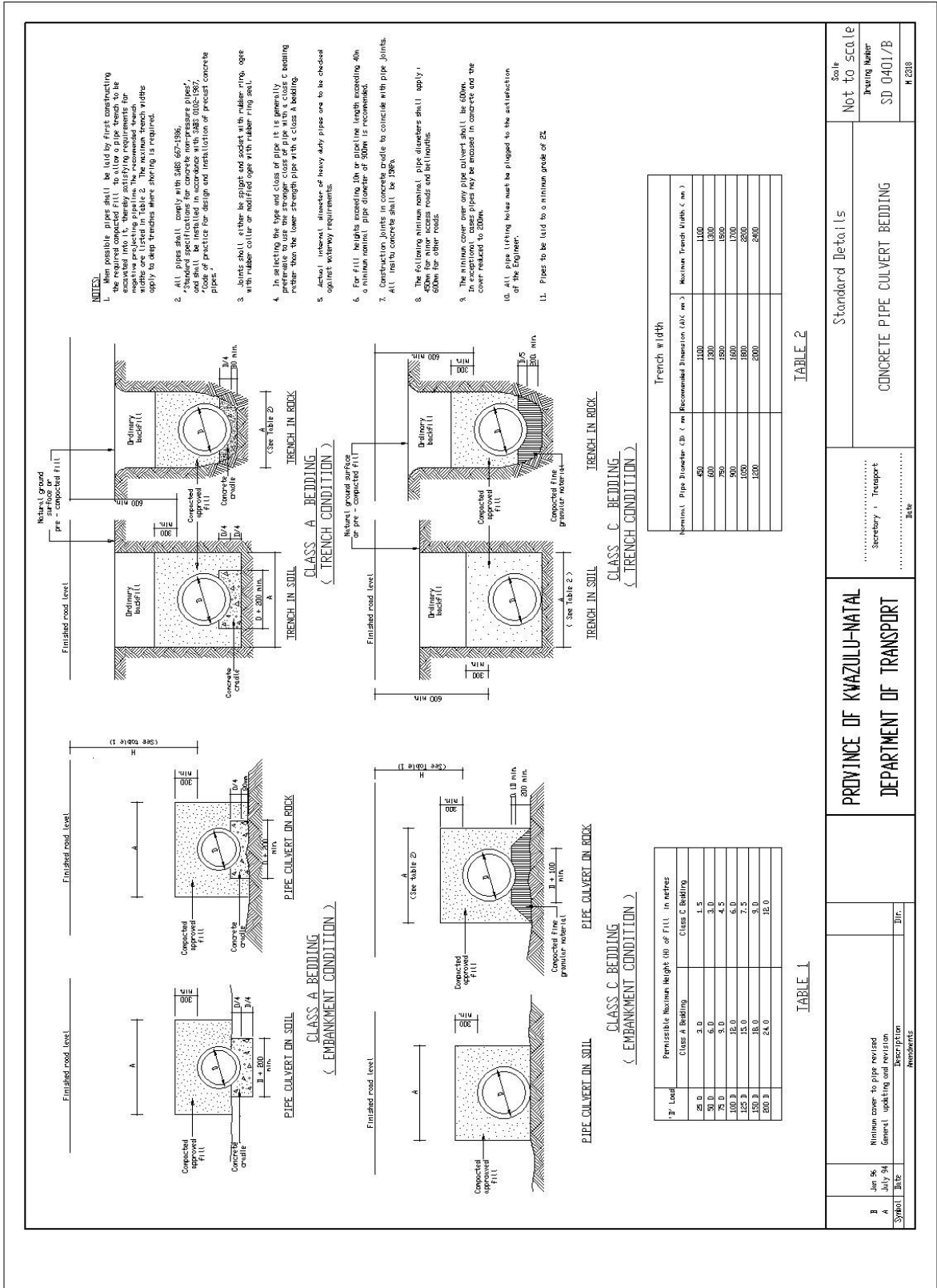

Scale
Not to scale

Standard Details

CONCRETE PIPE CULVERT BEDDING

Province of KwaZulu-Natal
Department of Transport

Secretary : Transport

Province of KwaZulu-Natal
Department of Transport

Minimum cover to pipe revised
General updating and revision

Symbol	Date	Description	Disc.

Revised

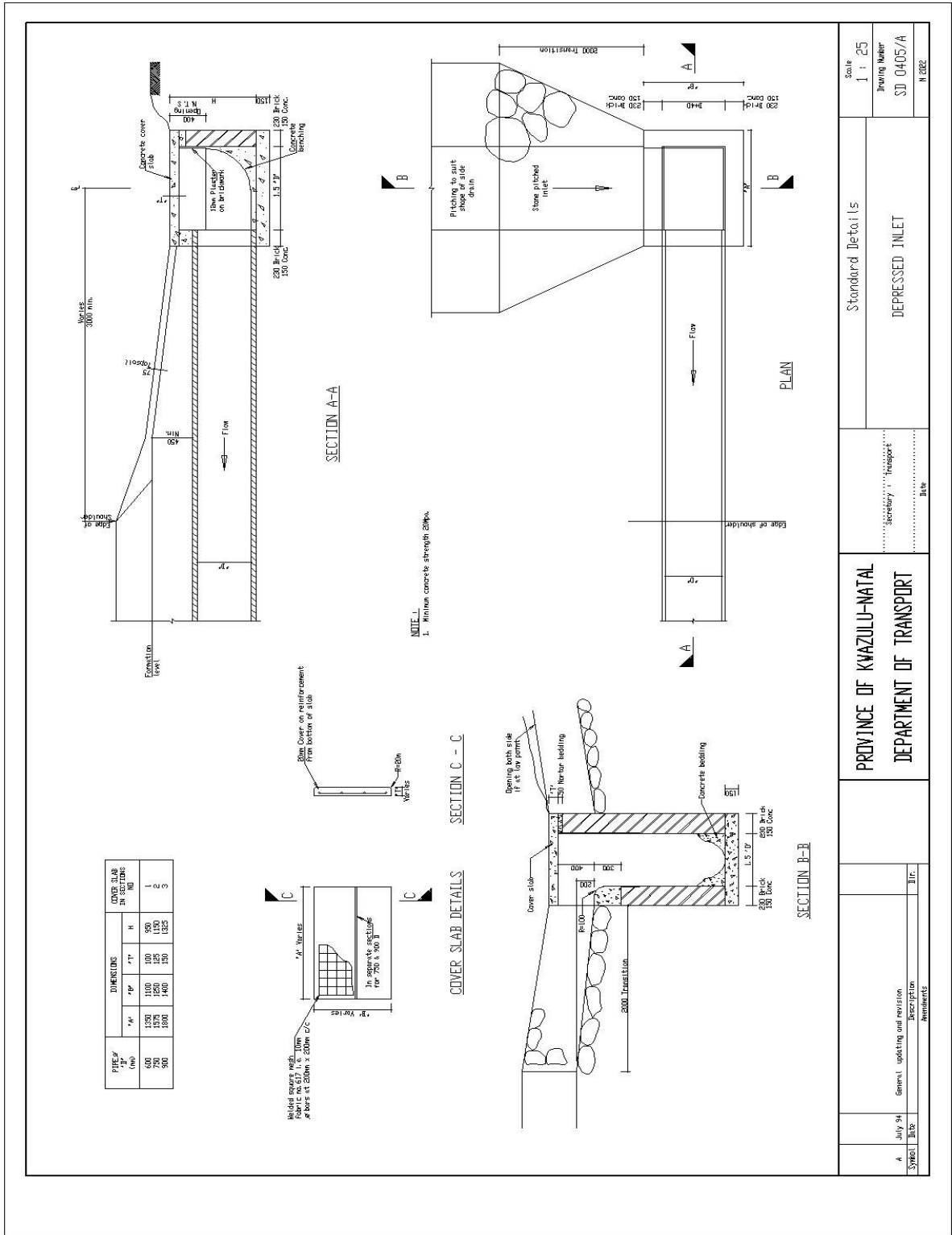

Scale
1 : 25
Drawing Number
SD 0405/A
N.2022

Standard Details
DEPRESSED INLET

Secretary: Transport
Date

PROVINCE OF KWAZULU-NATAL
DEPARTMENT OF TRANSPORT

SYMBOL	DATE	GENERAL	REVISION	DESCRIPTION	BY
A	July 94	General	update and revision		

NOTES:

- Splitter block and pitching to be provided at all outlets.
- Splitter block may be omitted if discharge velocity is less than 0.9 m/s.
- Out-off walls may be omitted if structure is founded on rock.
- For multiple pipe culverts increase dimensions 'E' and 'F' by $(n-1)(A+H)D/2n$; where n = number of pipes and A = nominal diameter of pipes.
- Pipes to be cast into concrete.
- For skew pipe culverts the headwall shall be parallel to the centre line of the road.
- If corrugated metal pipes are used 420mm/20mm long anchor bolts in the notches of the corrugation are to be used.
- All concrete is to be 20MPa.
- Square mesh fabric (Reference S.M.F. 193) is to be placed on top of the concrete in all sloped areas and centrally in cut-off walls.
- Brickwork is to consist of good quality burnt clay common bricks in accordance with SABS 250. Specific location, or uniform in size and shape, laid in stretcher bond with uniform joints with the skins tied together with galvanized crimped wire mesh.
- Brickwork is to be placed every 4th course.
- Jointing on all visible faces to be pointed.
- No infill shall be larger than a half standard brick size unless 10MPa concrete is used.

Nominal Dia.	Dimensions (mm)			
	A	B	C	E
480	555	1 050	2 700	1 500
600	705	1 400	3 500	1 900
900	1 050	2 100	5 200	2 800
1 200	1 400	2 800	7 000	3 700

TYPICAL RETAINING WALL DETAILS

PLAN OF SKEW CULVERT

LAYOUT OF BRICKWORK

	Standard Details	Scale N. T. S.
	PIPE CULVERT HEADWALL (MASONRY)	Drawing Number SD 0406
	Province of KwaZulu-Natal Department of Transport	H. 22821
Symbol	Description	Dr.
Date	Amendments	

3. PROCUREMENT

The contractor shall procure goods and services under provisional sums and prime cost sums according to the Employer's standards.

4. CONSTRUCTION

4.1 Applicable SANS 2001 standards for construction work

All construction work must conform with the relevant SABS or SANS specifications referred to in the 'Standard Specifications for Road and Bridge Works for South African Road Authorities (COTO), Draft Standard (DS), October 2020', or in Section C3.2 Project Specifications, Part B: Amendments to the Standard Specifications, of this document.

4.2 Applicable national and international standards

All construction work must be undertaken in accordance with the 'Standard Specifications for Road and Bridge Works for South African Road Authorities (COTO), Draft Standard (DS), October 2020 and as amended in Section C3.2 Project Specifications, Part B: Amendments to the Standard Specifications, of this document.

4.3 Particular / generic specifications

As well as the 'Amendments to the Standard Specifications' contained in Part B of Section C3.2 Project Specifications, of this document, the following Particular Specifications as contained in Section C3.3, are applicable to this Contract:

- Part C: Environmental Management Specification
- Part D: OHSA 1993 Health and Safety Specification
- Part E: Expanded Public Works Programme
- Part F: Small Contractor Development

The 'General Conditions of Contract for Construction Works, Third Edition (2015)', published by the South African Institution of Civil Engineering which is applicable to this Contract.

4.4 Certification by recognized bodies

No certification of items included in the Works is required.

4.5 Plant and materials provided by the Employer

No plant and materials are to be provided by the Employer.

4.6 Services and facilities provided by the Employer

The Employer's Agent's site office and laboratory facilities will be paid for in terms of the Contract. No other services or facilities are to be provided by the Employer.

5. MANAGEMENT

5.1 Applicable SANS 1921 standards

The following parts of SANS 1921 and associated specification data are applicable:

5.1.1 SANS 1921-1 Part 1: General engineering and construction works

Specification data associated with SANS 1921-1	
Clause No.	Essential data
4.1.7	There are no requirements for drawings, information and calculations for which the

Specification data associated with SANS 1921-1	
Clause No.	Essential data
	Contractor is responsible.
4.2.1	The responsibility strategy assigned to the Contractor for the works is 'A'.
4.3.1	The programme must conform to clause A1.2.7.1 (Scheme 1) 'Programme of Work' of the Standard Specifications for Road and Bridge Works for South African Road Authorities (COTO), Draft Standard (DS), October 2020 and clause 5.6 'Programme' of the 'General Conditions of Contract 2015'.
4.3.3	The Contractor must give 24 hours' notice for inspection of work that is to be covered up.
4.7.3	Where applicable, the Contractor is afforded the opportunity of pricing an item to cover costs of unavoidable over-break.
4.12.2	The samples of materials, workmanship and finishes that the Contractor is to provide and deliver to the Employer/Employer's Agent are to be as described in clause A1.2.8 'Workmanship and Quality Control' of the Standard Specifications for Road and Bridge Works for South African Road Authorities (COTO), Draft Standard (DS), October 2020 and clause 7 'Quality and Related Matters' of the 'General Conditions of Contract 2015'.
4.12.2	The fabrication drawings that the Contractor is to provide to the Employer are: none.
4.14.5	The Contractor is to provide latrine and ablution facilities as described in Part C 'Environmental Management Plan' in Section C3.3 Particular Specifications of these Project Specifications.
4.14.6	The requirements for the provision and erection of signboards are as described in clause A1.2.3.10 'Notices, Signs and Advertisements' of the Standard Specifications for Road and Bridge Works for South African Road Authorities (COTO), Draft Standard (DS), October 2020, and as detailed in the 'Example of Contract Signboard Details' in Section C4: Site Information of these Project Specifications.
4.17.1	The requirements for the termination, diversion or maintenance of existing services are described in clause A1.2.7.3 and Chapter 2 of the Standard Specifications for Road and Bridge Works for South African Road Authorities (COTO), Draft Standard (DS), October 2020.
4.17.3	Services that are known to exist on the site are described in clause A1.2.7.3 and Chapter 2 of the Standard Specifications for Road and Bridge Works for South African Road Authorities (COTO), Draft Standard (DS), October 2020.
4.17.4	The requirements for detection apparatus for locating underground services are: none.
4.18	The additional health and safety requirements are described in Part D 'OHS 1993 Health and Safety Specification' in Section C3.3 Particular Specifications of these Project Specifications.

5.1.1.1 Additional clauses:

(a) Site meetings and procedures

Site meetings shall be convened as described in clause A1.2.3.16 'Monthly Site Meetings' of the Standard Specifications for Road and Bridge Works for South African Road Authorities (COTO), Draft Standard (DS), October 2020. The Contractor shall keep on site a set of minutes of all site meetings, daily records of resources (people and equipment employed), a site memoranda book, a complete set of contract working drawings and a copy of the procurement document, and shall make these available at all reasonable times to all persons concerned with the contract.

(b) Water and electricity

The Contractor is to provide water and electricity as described in clauses A1.2.3.21 'Water' and A1.4.7.3 'Services' of the Standard Specifications for Road and Bridge Works for South African Road Authorities (COTO), Draft Standard (DS), October 2020.

5.1.2 SANS 1921-6 Part 6: HIV/AIDS awareness

Specification data associated with SANS 1921-6	
Clause No.	Essential data
4.2.1(a)	A qualified service provider is one that is an accredited or provisionally accredited

	training service provider in the HIV/AIDS field. A list of accredited service providers can be obtained from the Construction SETA (CETA) (tel. 011 265 5900), Health and Welfare SETA (HWSETA) (011 622 6852) or on the Health and Welfare SETA website: www.hwseta.org.za .
4.2.1(a)	The HIV/AIDS awareness programme is to be repeated at four monthly intervals throughout the duration of the contract.

5.1.2.1 Additional clauses:

(a) Workshops

The duration of each workshop shall not be less than 2½ hours.

5.2 Recording of weather

The Contractor shall erect a rain gauge and record the rainfall as described in clause A1.2.3.4 of the Standard Specifications for Road and Bridge Works for South African Road Authorities (COTO), Draft Standard (DS), October 2020. This information together with other details of the prevailing weather conditions shall be recorded in the daily site diary.

5.3 Unauthorised persons

The Contractor shall keep unauthorised persons away from the Works at all times. Under no circumstances may the Contractor's personnel be accommodated on the site.

5.4 Management meetings

Management meetings are to be held weekly at a time convenient to all concerned, to discuss planning and health and safety amongst other things. Attendance by the Construction Manager and the Employer's Agent's Representatives on site is mandatory, and attendance by other interested parties will be by invitation.

5.5 Forms for contract administration

The Employer's Agent's Representative will provide standard forms for 'Site Diary', 'Site Memoranda', 'Requests for Inspection' and any others deemed to be necessary during the contract.

5.6 Electronic payments

Payments of approved payment claims will be made electronically upon submission of the Contractor's banking details.

5.7 Daily records

A site diary is to be compiled jointly by the Construction Manager and the Employer's Agent's Representatives on site and is to be agreed and signed by both parties. The original signed copy is to be retained by the Employer's Agent's Representative.

The Contractor is to keep daily records of people and equipment on site in a format to be agreed by the Employer's Agent's Representative, and is to provide copies to the Employer's Agent's Representative when requested.

5.8 Payment certificates

Details of measurements, proof of payment for items contained in provisional sums and prime cost sums, proof of ownership of Plant and materials on site and documentation pertaining to contract price adjustment and special materials, are required as substantiation of claims for payment.

5.9 Permits

No security/entrance permits are required by the Contractor's personnel to enter the site.

5.10 Proof of compliance with the law

There are no requirements for the Contractor to verify compliance with any legislation.

5.11 Submission of reports

The contractor shall submit monthly reports in accordance with the specifications in Part E: Expanded Public Works Programme and Part F: Small Contractor Development.

C3.2: PROJECT SPECIFICATIONS

PART B: AMENDMENTS TO THE STANDARD SPECIFICATIONS

PROJECT SPECIFICATIONS RELATING TO THE STANDARD SPECIFICATIONS AND OTHER ADDITIONAL SPECIFICATIONS

In certain clauses in the Standard Specifications for Road and Bridge Works for South African Road Authorities (COTO), Draft Standard (DS), October 2020, allowance is made for a choice to be specified in the Project Specifications between alternative materials or methods of construction, and for additional requirements to be specified to suit a particular contract. Details of such alternatives or additional requirements applicable to this Contract are contained in this part of the Project Specifications. It also contains the necessary additional specifications required for this Contract.

The clauses and payment items dealt with in this part of the Project Specifications are numbered 'PS' with a number corresponding to the relevant clause or item number in the Standard Specifications for Road and Bridge Works for South African Road Authorities (COTO), Draft Standard (DS), October 2020.

New clauses and payment items not covered by clauses or items in the Standard Specifications for Road and Bridge Works for South African Road Authorities (COTO), Draft Standard (DS), October 2020 have been included here and have also been designated with the prefix 'PS'. Such clauses and items have been given a new number following upon the last number used in the particular chapter referred to in the Standard Specifications for Road and Bridge Works for South African Road Authorities (COTO), Draft Standard (DS), October 2020.

CHAPTER 1.2 GENERAL REQUIREMENTS AND PROVISIONS

PART A: SPECIFICATION

PSA1.2.3.11 ORDERING OF DAYWORKS

Replace Clause A1.2.3.11 with the following:

PSA1.2.3.11 DAYWORKS

a. Scope

Rates for daywork shall be entered in the under item C1.2.8.1 in accordance with the following specifications.

b. Daywork Rates

According to Clause 6.5 of the General Conditions of Contract 2015, certain work may be carried out using rates tendered in the daywork schedule. A schedule of personnel, construction equipment and vehicles which may be required to perform work on a daywork basis is included in the Bill of Quantities. The quantities used in the Bill of Quantities are for tender evaluation purposes only and the use or not of these items shall not constitute a variation in terms of Clause 6.3 of the General Conditions of Contract 2015.

No work will be paid for as daywork without the written instruction or approval of the Employer's Agent.

c. Type of Work

The Employer's Agent may order daywork in certain cases where it is necessary to vary or to extend the works due to new or unforeseen circumstances to such an extent that the tendered rates for specific items of work are no longer applicable, or where no suitable combination of tendered rates can be used to pay for such work.

As a general rule, applicable rates for additional work items will be agreed between the Contractor and the Employer's Agent. Daywork will only be used in exceptional circumstances.

d. Materials

Materials for use in works carried out under daywork shall be purchased by the Contractor who shall also arrange for delivery to site, and shall be responsible for any other requirements associated with specific materials. A Provisional Sum has been allowed in C1.2.8 of the Bill of Quantities for daywork materials. The Contractor shall enter a tendered percentage in the Bill of Quantities to cover his handling costs and profit, as per other provisional and prime cost sums in this Contract.

Materials shall be paid for using the method described in C2.1, 'Pricing Assumptions'. No contract price adjustment will be applicable to materials.

The Contractor shall submit proof of ownership for any materials used in daywork with his daywork claim to the Employer's Agent. Further, if specific materials are required for daywork, quotations will be called for as per Clause 6.5.2 of the General Conditions of Contract 2015.

e. Construction Equipment

Where daywork is ordered, the tendered rates for construction equipment in C1.2.8 of the Bill of Quantities shall be used in calculating the payment due for any construction equipment required to execute the daywork. If no rate is included in the Bill of Quantities for a particular item of construction equipment, and where no other rate or combination of rates would provide suitable compensation, then the daywork method of payment described in Clause 6.5.1.3 of the General

Conditions of Contract 2015 will be used.

The tendered rates for each item of construction equipment shall include for all operating costs associated with the said item of construction equipment. Such costs are deemed to include fuel, re-fuelling costs, lubrication and routine servicing / maintenance, breakdowns and spares, all overhead costs, site management costs and administration costs. The tendered rates shall also include the construction equipment operator and the general supervision of the construction equipment while it is engaged in the daywork.

f. Salaries and Wages of Workmen

The salaries and wages of workmen executing daywork shall be paid for using the tendered rates in the Bill of Quantities. The tendered rates shall include for all costs associated with the employment of personnel, including salaries, wages, allowances, workmen's compensation, medical aid and pension contributions, government levies and taxes, training costs and any costs associated with living on the site. The tendered rates shall also include for the transportation of the workmen to the site of the daywork.

All overhead costs, administration costs, site management costs and the Contractor's profit are deemed to be covered by the daywork rates and no additions or mark ups will be made to the tendered rates.

The tendered rates shall also include any hand tools normally associated with the workmen's job description e.g. picks, shovels, hammers, saws and spirit levels. The tendered rate for labourers shall also include for the casual supervision by a gang leader or foreman. Only when specifically called for by the Employer's Agent, will payment be made for the use of a gang leader or foreman supervising on a continuous basis.

g. Measurement and Payment

The following principles shall also apply to the measurement and payment of daywork.

The unit of measurement for construction equipment shall be the number of Vibroclock hours worked and each item of construction equipment shall be fitted with a Vibroclock, the cost of which shall be included in the rates. Excessive non-productive time when the engine is idling will not be paid for. Where there is ambiguity between the flywheel horsepower and mass of the machine, the flywheel horsepower shall govern the measurement category. Where width and mass are specified, mass shall govern the measurement category.

The Contractor's attention is drawn to the requirements of Clauses 6.5.3 and 6.5.4 of the General Conditions of Contract 2015 with regard to the submission of lists and statements of personnel, materials and construction equipment used for daywork.

The payment items under C1.2.8 in the Standard Specifications for Road and Bridge Works for South African Road Authorities (COTO), Draft Standard (DS), October 2020 will be applicable.

PSA1.2.3.18 Stakeholder liaison

Add the following to Clause A1.2.3.18:

a. Project Liaison Committee

The process of implementing infrastructure projects will be undertaken by means of structured engagement between those responsible for the delivery of the project and the community.

A Project Liaison Committee (PLC) is a vital means of communication between the parties involved with the project. A PLC may be formed if the project is such that a specific community can be identified.

The PLC comprises representatives of the employer, the engineer and formal structures within the community. The contractor shall make use of these communication channels, and shall appoint from amongst his site personnel a responsible person to participate in the affairs of the PLC, and this representative shall also attend the monthly PLC meetings when so requested.

The PLC shall meet at least once every month until such time as it is of the opinion that it could fulfil its tasks by meeting less frequently.

The PLC deals with local labour on the project, and is tasked with:

- assisting with community liaison and the resolution of community disputes;
- devising fair and transparent procedures that will assist the contractor in the engagement of labour;
- advising on and monitoring labour issues; and
- assisting in the resolution of labour disputes.

All labour recruitment, employment and associated risks shall remain the sole responsibility of the contractor.

A new pay item is included in Chapter 1.2 of the schedule of quantities relating to the payment of the PLC on a provisional sum basis. Payment under this item shall be made only for the period for which the duties of the PLC are required, and not necessarily for the full duration of the contract.

b. Community Liaison Officer (CLO)

The contractor, after consultation with the Project Liaison Committee (PLC), shall appoint a competent local person as a Community Liaison Officer (CLO). The contractor shall appoint the CLO as part of his site personnel, and shall direct all his liaison efforts with the local community through the appointed CLO.

The period of employment and the remuneration of the CLO shall be determined jointly by the contractor, the engineer and the employer.

The CLO shall:

- i. represent the community and assist the contractor, the engineer and the employer with communication between them and the community;
- ii. work an 8-hour day with a total of 40 hours worked per week, and shall be present on site each day except when performing off-site community liaison activities;
- iii. communicate daily with the contractor on labour related issues such as numbers and skill;
- iv. assist in the identification and screening of local labourers from the community in accordance with the contractor's requirements;
- v. inform local labour of their conditions of employment, including their period of employment;
- vi. attend disciplinary proceedings involving local labour, and ensure that hearings are fair and reasonable;
- vii. attend all meetings at which the community and/or local labour are present or are required to be represented;
- viii. attend monthly site meetings to report on community and local labour matters;
- ix. keep a daily written record of interviews and community liaison;
- x. submit monthly returns regarding community liaison; and
- xi. carry out all such other duties as agreed upon between all parties concerned.

A new pay item is included in Chapter 1.2 of the schedule of quantities relating to the payment of the CLO on a provisional sum basis. Payment under this item shall be made only for the period for which the duties of the CLO are required, and not necessarily for the full duration of the contract.

Add the following new Clause A1.2.3.24:

PSA1.2.3.24 Compliance with the Road Traffic Act

When a service necessitates vehicles or plant travelling or working on a public road, the following shall apply:

- The vehicles and plant shall be licensed in terms of the National Road Traffic Act 1996 (Act No. 93 of 1996) as amended.
- Every driver and operator of a vehicle or an item of plant shall be in possession of a valid permit in respect of the class of vehicle or item of plant he / she is driving or operating.

The Contractor shall provide, erect and maintain sufficient road signs, barricades, fencing and guarding as may be necessary or required by the Employer's Agent or by any act, regulation or statutory authority in order to minimise the danger and inconvenience caused to vehicle and pedestrian traffic. The Contractor by accepting this contract shall be deemed to have indemnified the Employer and the Employer's Agent against any claims, damages and / or costs that may arise in this regard.

Add the following new payment item.

C3.3: PARTICULAR SPECIFICATIONS

In addition to the Standard Specifications and the Project Specifications, the following Particular Specifications shall apply to this contract and are bound in hereafter:

PART C: ENVIRONMENTAL MANAGEMENT SPECIFICATION	C59
PART D: DAYWORK.....	C65
PART E: OHS&A 1993 HEALTH AND SAFETY SPECIFICATION	C69
PART F: EXPANDED PUBLIC WORKS PROGRAMME.....	C77

3.3 PARTICULAR SPECIFICATIONS

PART C: ENVIRONMENTAL MANAGEMENT SPECIFICATION

PART C: ENVIRONMENTAL MANAGEMENT SPECIFICATION

C1. SCOPE

The Employer recognises environmental management as a key component of road infrastructure development and as part of its environmental policy has developed this environmental management specification as a tool for continual improvement in environmental performance.

This environmental management specification prescribes the methods by which proper environmental controls are to be implemented by the Contractor. The duration over which the Contractor's controls shall be in place cover the construction period of the project as well as the limited time after contract completion defined by the General Conditions of Contract 2015 as the Defects Notification Period (maintenance period).

C2. ENVIRONMENTAL MANAGEMENT PLAN

In order to ensure that the construction work is carried out in an environmentally sensitive manner, strict compliance with the Environmental Management Plan (EMP) guidelines is required. The purpose of the EMP is to:

- Encourage good management practices through planning and commitment to environmental issues,
- Provide rational and practical environmental guidelines to:
 - (i) Minimise disturbance of the natural environment,
 - (ii) Prevent pollution of land, air and water,
 - (iii) Prevent soil erosion and facilitate re-vegetation.
- Adopt the best practicable means available to prevent or minimise adverse environmental impact,
- Develop waste management practices based on prevention, minimisation, recycling, treatment or disposal of wastes,
- Train employees and contractors with regard to environmental obligations.

C3. ADMINISTRATION OF ENVIRONMENTAL OBLIGATIONS

The Contractor is responsible for the implementation of this EMP to ensure sound environmental management during the construction phase of a project.

The Contractor shall receive and implement any instruction issued by the Employer's Agent relating to compliance with the EMP including the removal of personnel or equipment.

Compliance with the provisions contained herein or any condition imposed by the environmental approvals, shall become the responsibility of the Contractor through an approved Environmental Officer (EO). The Contractor shall nominate a person from among his site personnel to fulfil this function and submit to the Employer's Agent for his approval the curriculum vitae of the proposed EO. This request for approval shall be given, in writing, at least fourteen days before the commencement of any construction activity clearly setting out reasons for the nomination, and with sufficient detail to enable the Employer's Agent to make a decision.

Once a nominated representative of the Contractor has been approved as the EO, the EO shall be the responsible person for ensuring that the provisions of this EMP are complied with for the duration of the contract. The EO shall submit monthly written reports of compliance with the EMP to the Employer's Agent.

In addition to the compliance duties relating to this EMP, the EO shall also provide full cooperation whenever the Contractor is subjected to regular environmental audits.

C4. TRAINING AND INDUCTION OF EMPLOYEES

The Contractor has a responsibility to ensure that all those people involved in the project are aware of and familiar with the environmental requirements for the project (this includes subcontractors and local labour). The EMP shall be part of the terms of reference for all contractors, subcontractors and suppliers.

C5. COMPLAINTS REGISTER AND ENVIRONMENTAL INCIDENT BOOK

Any complaints received by the project team from the public will be recorded. The complaint should be brought to the attention of the Construction Manager, who will respond.

The following information must be recorded:

- Time, date and nature of the complaint,
- Type of communication (telephone, letter or email),
- Name, contact address and telephone number of the complainant,
- Response and investigation undertaken, and
- Actions taken and by whom.

All complaints received will be investigated and a response given to the complainant within 14 days.

All environmental incidents occurring on the site will be recorded. The following information will be provided:

- Time, date, location and nature of the incident, and
- Actions taken and by whom.

C6. SITE CLEANLINESS AND NEATNESS

- Location of a construction camp is to be approved by the Employer's Agent and is to be restored to its previous condition after completion of construction.
- The construction camp should preferably be fenced with a 1,8m Bonnox fence or similar approved.
- All materials, equipment, plant and vehicles must be stored within the construction camp.
- A dedicated area must be made available for construction staff to change and store their personal belongings.

C7. ACCESS

- Access to existing roads, schools, buildings, shops and residential properties must not be impeded during construction.
- Access roads utilised by the Contractor must be maintained in good condition.

C8. BORROW PITS

- Mining authorisations (permits) for borrow pits must be obtained from the Department of Mineral Resources (DMR) in consultation with the Department of Water and Sanitation (DWS).
- Spoil dumps resulting from borrow pits must not interfere with any natural surface drainage.
- Borrow pits must be rehabilitated after use in accordance with the requirements of DMR and DWS.

C9. DUST CONTROL / AIR QUALITY

- Dust suppression measures must be implemented during construction by ensuring that all surfaces prone to dust generation are kept damp (e.g. use of water tanker).
- Ensure that vehicles and equipment are in good working condition and that emissions are not excessive.
- Special care must be taken in areas where the route passes close to schools and residential areas.
- The speed of construction vehicles must be reduced.

C10. FAUNA

- Contractors' and subcontractors' staff and workers may not chase, catch or kill animals encountered during construction.

C11. FIRE PREVENTION AND CONTROL

- Smoking is prohibited in the vicinity of flammable substances.
- The Contractor must ensure that fire-fighting equipment is available on site, particularly where flammable substances are being stored or used, and that construction staff are aware of where it is kept and how it is operated.
- Fires started for comfort (warmth) are prohibited, due to the risk of veld fires and risk to adjacent property owners' lands.

C12. GRAVE SITES

- Grave sites in close proximity to the road must not be disturbed during construction.

C13. MATERIALS HANDLING AND SPILLS MANAGEMENT

- Any hazardous materials to be used during construction (e.g. lime, fuel and paint) are to be stored in a designated area at the campsite.
- The storage containers/facilities (including any diesel or petrol tanks) must be placed on an impermeable surface and surrounded by a bund wall, in order to ensure that accidental spillage does not pollute the environment.
- Workers must at all times be made aware of the health and safety risks associated with any hazardous substances used (e.g. smoking near fuel tanks), and must be provided with appropriate protective clothing/equipment in case of spillages or accidents.
- Ensure all staff and contractors undergo relevant training in the maintenance of equipment to prevent the accidental discharge or spill of fuel, oil, lubricants and other chemicals.
- Any spill of potentially hazardous materials must be cleaned up immediately (potentially hazardous materials on site include paint, oil, grease, fuel and turpentine).
- The area of contaminated soil or spill must be deposited into the hazardous waste container(s).
- The Contractor should keep Peat Sorb or a similar absorbent on site to clean up any spills. The absorbent must be stored in a designated area and be available for inspection.
- All spills are to be recorded in the environmental incident book.

C14. NOISE

- Noise generating activities must be restricted to between 07:00 and 17:00 Monday to Friday, unless otherwise approved by the appropriate competent person in consultation with adjacent landowners/affected persons.
- All equipment, vehicles and machinery must be in good working condition and be equipped with sound mufflers if necessary.
- Construction staff must be trained and made aware of not creating unnecessary noise such as hooting and shouting.

C15. POLLUTION CONTROL

- Soil and water pollution through usage of fuel, oil, paint, bitumen or other hazardous substances must be avoided.
- All construction vehicles are to be maintained in good working order so as to prevent soil or water pollution from oil, fuel or other leaks, and to reduce noise pollution.

C16. RIVERS AND STREAMS

- During construction of bridge structures, there must be no obstruction of the water flow of rivers and streams.
- Excavated material must not be stockpiled on or near riverbanks, in order to prevent sedimentation occurring.
- Erosion control measures must be employed both during and after construction.
- No impediments to natural surface water flow, other than approved erosion control measures,

must occur.

C17. SAFETY

- Safety measures, such as detour signs, must be implemented during construction to ensure the safety of workers, pedestrians and drivers/passengers in vehicles in the vicinity of construction work.
- Special care must be taken in the vicinity of schools to ensure the safety of children wishing to cross the road under construction.
- The relevant signage (e.g. speed control signs) must be erected alongside the road during the operation phase in order to control traffic.
- Accommodation must be made for pedestrian pathways alongside the road during the construction and operation phases.

C18. SOIL MANAGEMENT

- Storm water drainage pipes must be installed alongside the road in all areas susceptible to soil erosion.
- Erosion should be minimised by the construction of meadow drains and the planting of indigenous vegetation on the side slopes and drains to reduce flow velocity of storm water.
- Spoil from cuts may be used in existing erosion gullies.
- Stone pitching and gabions should be constructed at pipe culvert outlets.
- Accidental spills of contaminants onto the ground e.g. oil, concrete, fuel and chemicals should be removed together with the contaminated soil.
- If necessary, an absorbent such as Peat Sorb should be used to aid in cleaning up the spill. The contaminated soil should be disposed of in an appropriate container, depending on its classification.
- Servicing and refuelling of vehicles must only be carried out at the construction camp.

C19. WORKER CONDUCT

Code of Conduct for Construction Personnel:

- Do not leave the construction site untidy and strewn with rubbish which will attract animal pests.
- Do not set fires.
- Do not cause any unnecessary, disturbing noise at the construction camp/site or at any designated worker collection/drop off points.
- Do not drive a construction-related vehicle under the influence of alcohol.
- Do not exceed the national speed limits on public roads or exceed the recommended speed limits on the site.
- Do not drive a vehicle which is generating excessive noise or gaseous pollution (noisy vehicles must be reported and repaired as soon as possible).
- Do not litter along the roadsides, including both the public and private roads.
- Do not pollute any water bodies (whether flowing or not).
- No member of the construction team is allowed to enter the areas outside the construction site.

C20. TRAFFIC DISTURBANCES AND DIVERSIONS

- Any traffic diversions must be undertaken with the approval of all relevant authorities and in accordance with all relevant legislation.
- Wherever possible, traffic diversion must only take place on existing disturbed areas and remain within the existing road reserve.
- Traffic diversion routes must be rehabilitated after use.

C21. VEGETATION

- Only vegetation falling directly on the route must be removed where necessary.
- Alien vegetation within the road reserve must be eradicated, and management measures must be implemented for future control of these species.

Vegetation that has been removed from large areas (e.g. on traffic diversion routes) during

- construction must be replaced with indigenous vegetation after construction has been completed.

C22. WASTE MANAGEMENT

- All general, non-hazardous waste must be placed in a skip container and disposed of at a registered waste disposal site.
- The Contractor is to ensure that the portable toilet facilities at the campsite are properly maintained and in working order.
- No disposal, or leakage, of sewage must occur on or near the site.
- All hazardous waste (e.g. oil, paint, empty lime bags, and contaminated wash water) must be stored in leakproof containers and disposed of at a registered hazardous waste disposal site.
- The contents of waste storage containers must, under no circumstances, be emptied to the surrounding area. In general, littering, discarding or burying of any materials is not allowed on site or along the route.
- Adequate waste receptacles must be available at strategic points around the construction camp and site for all domestic refuse and to minimise the occurrence of littering.
- Concrete rubble must be collected and disposed of as directed by the Employer's Agent.
- Each working area must be cleared of litter and building waste (e.g. rubble, wood and concrete packets) on completion of the day's work.
- Any spill around the container(s) should be treated as per clause C13 and C18.

C23. MEASUREMENT AND PAYMENT

The contractor shall make provision in the various rates and prices for all costs related to the environmental management specification and measures required in terms of legislation. Provision is made in item B13.02 of the Bill of Quantities for the contractor's general obligations, risks and liabilities in accordance with the environmental management specification.

3.3 PARTICULAR SPECIFICATIONS

PART D: DAYWORK

PART D: DAYWORK

D1. SCOPE

This part deals with the provision for daywork in the Bill of Quantities. Rates for daywork shall be entered in the Bill of Quantities in accordance with the following specifications.

D2. DAYWORK RATES

According to Clause 6.5 of the General Conditions of Contract 2015, certain work may be carried out using rates tendered in the daywork schedule. A schedule of personnel, construction equipment and vehicles which may be required to perform work on a daywork basis is included in the Bill of Quantities. The quantities used in the Bill of Quantities are for tender evaluation purposes only and the use or not of these items shall not constitute a variation in terms of Clause 6.3 of the General Conditions of Contract 2015.

No work will be paid for as daywork without the written instruction or approval of the Employer's Agent.

D3. TYPE OF WORK

The Employer's Agent may order daywork in certain cases where it is necessary to vary or to extend the works due to new or unforeseen circumstances to such an extent that the tendered rates for specific items of work are no longer applicable, or where no suitable combination of tendered rates can be used to pay for such work.

As a general rule, applicable rates for additional work items will be agreed between the Contractor and the Employer's Agent. Daywork will only be used in exceptional circumstances.

D4. MATERIALS

Materials for use in works carried out under daywork shall be purchased by the Contractor who shall also arrange for delivery to site, and shall be responsible for any other requirements associated with specific materials. A Provisional Sum has been allowed in Section D of the Bill of Quantities for daywork materials. The Contractor shall enter a tendered percentage in the Bill of Quantities to cover his handling costs and profit, as per other provisional and prime cost sums in this Contract.

Materials shall be paid for using the method described in C2.1, 'Pricing Assumptions'. No contract price adjustment will be applicable to materials.

The Contractor shall submit proof of ownership for any materials used in daywork with his daywork claim to the Employer's Agent. Further, if specific materials are required for daywork, quotations will be called for as per Clause 6.5.2 of the General Conditions of Contract 2015.

D5. CONSTRUCTION EQUIPMENT

Where daywork is ordered, the tendered rates for construction equipment in Section D of the Bill of Quantities shall be used in calculating the payment due for any construction equipment required to execute the daywork. If no rate is included in the Bill of Quantities for a particular item of construction equipment, and where no other rate or combination of rates would provide suitable compensation, then the daywork method of payment described in Clause 6.5.1.3 of the General Conditions of Contract 2015 will be used.

The tendered rates for each item of construction equipment shall include for all operating costs associated with the said item of construction equipment. Such costs are deemed to include fuel, re-fuelling costs, lubrication and routine servicing / maintenance, breakdowns and spares, all overhead costs, site management costs and administration costs. The tendered rates shall also include the construction equipment operator and the general supervision of the construction equipment while it is engaged in the daywork.

D6. SALARIES AND WAGES OF WORKMEN

The salaries and wages of workmen executing daywork shall be paid for using the tendered rates in the Bill

of Quantities. The tendered rates shall include for all costs associated with the employment of personnel, including salaries, wages, allowances, workmen's compensation, medical aid and pension contributions, government levies and taxes, training costs and any costs associated with living on the site. The tendered rates shall also include for the transportation of the workmen to the site of the daywork.

All overhead costs, administration costs, site management costs and the Contractor's profit are deemed to be covered by the daywork rates and no additions or mark ups will be made to the tendered rates.

The tendered rates shall also include any hand tools normally associated with the workmen's job description e.g. picks, shovels, hammers, saws and spirit levels. The tendered rate for labourers shall also include for the casual supervision by a gang leader or foreman. Only when specifically called for by the Employer's Agent, will payment be made for the use of a gang leader or foreman supervising on a continuous basis.

D7. MEASUREMENT AND PAYMENT

The following principles shall also apply to the measurement and payment of daywork.

The unit of measurement for construction equipment shall be the number of Vibroclock hours worked and each item of construction equipment shall be fitted with a Vibroclock, the cost of which shall be included in the rates. Excessive non-productive time when the engine is idling will not be paid for. Where there is ambiguity between the flywheel horsepower and mass of the machine, the flywheel horsepower shall govern the measurement category. Where width and mass are specified, mass shall govern the measurement category.

The Contractor's attention is drawn to the requirements of Clauses 6.5.3 and 6.5.4 of the General Conditions of Contract 2015 with regard to the submission of lists and statements of personnel, materials and construction equipment used for daywork.

C3.3 PARTICULAR SPECIFICATIONS

PART E: OHS&A 1993 HEALTH AND SAFETY SPECIFICATION

PART E: OHS 1993 HEALTH AND SAFETY SPECIFICATION

E1. SCOPE

This part covers the health and safety requirements to be met by the Contractor to ensure a continued safe and healthy working environment for all employees, subcontractors, the Employer, the Employer's Agent, inspectors and all other persons entering the site of works.

This specification shall be read in conjunction with the Occupational Health and Safety Act, 1993 (Act No 85 of 1993 and amendment Act No 181 of 1993) and the corresponding Construction Regulations 2014, and all other safety codes and specifications referred to in the said Act and Construction Regulations.

In terms of the OHS 1993 Agreement in Section C1.4 of the Contract document, the status of the Contractor as mandatory to the Employer (client) is that of an employer in his own right, responsible for compliance with all provisions of OHS 1993 and the Construction Regulations 2014.

This specification and the Contractor's own Health and Safety Plan as well as the Construction Regulations 2014, shall be displayed on site or made available for inspection by inspectors, the Employer, the Employer's Agent, the Construction Health and Safety Agent, subcontractors, employees, representatives of trade unions and any other persons entering the site of works.

E2. DEFINITIONS

For the purpose of this contract the following shall apply:

E2.1 **"Construction Health and Safety Agent"** (CHSA) means any competent person who acts as a representative for the Employer in managing health and safety on a construction project for the Employer and who has satisfied the registration criteria of the SACPCMP to perform the required functions.

E2.2 **"Contractor"** where used in the contract documents and in this specification, means the Contractor as defined in the General Conditions of Contract 2015, and it shall have the exact same meaning as **"principal contractor"** as defined in the Construction Regulations 2014. **"Contractor"** and **"principal contractor"** are therefore interchangeable and shall be read in the context of the relevant document.

In this specification the terms **"principal contractor"** and **"contractor"** are replaced with **"Contractor"** and **"subcontractor"** respectively.

For the purpose of this contract the Contractor will, in terms of OHS 1993, be the mandatory, without derogating from his status as an employer in his own right.

E2.3 **"Employer"** where used in the contract documents and in this specification, means the Employer as defined in the General Conditions of Contract 2015 and it shall have the exact same meaning as **"client"** as defined in the Construction Regulations 2014. **"Employer"** and **"client"** are therefore interchangeable and shall be read in the context of the relevant document.

E2.4 **"Employer's Agent"** where used in this specification, means the Employer's Agent as defined in the General Conditions of Contract 2015.

E3. EMPLOYER'S BASELINE RISK ASSESSMENT

E3.1 Risk information

The information presented in this clause is based on the Employer's baseline risk assessment prepared specifically for this contract.

This information describes the type of work required in terms of this contract that will be accompanied by dangers, hazards and risks which the Contractor shall be required to identify, analyse, manage, monitor and review in terms of the Health and Safety Plan and risk assessments.

This information is neither prescriptive nor exhaustive, and is provided as a guideline to Tenderers in

preparing their tender submissions, and to the successful Contractor as a basis for the preparation of the site-specific risk assessments to be performed by the Contractor in terms of Construction Regulation 9.

Tenderers shall make their own assessment of the dangers, hazards and risks that can be expected during the course of this contract, which may include dangers, hazards and risks not identified in the baseline risk assessment, including those that may arise from specific methods of construction employed by the Contractor, and shall make due allowance in their tendered rates and prices for all costs related to complying with the provisions of the Act and Construction Regulations.

This information is given in good faith for the guidance of Tenderers, and no additional payment shall be made as a result of any inaccuracies, discrepancies or omissions contained therein.

E3.2 Baseline risk assessment

The Baseline Risk Assessment for the project prepared are by the Employer in terms of Construction Regulation 5(1)(a).

E3.3 Guidelines for construction and maintenance projects under Covid-19 Lockdown

The Employer has prepared guidelines which set out the key principles and minimum requirements that define responsible, healthy and safe operations for road construction operations under COVID-19 Lockdown conditions, for the Contractor to comply with. In addition, the Contractor shall comply with any new COVID-19 Regulations issued by Government.

The guidelines have been included as Annexure A at the end of this Project Document.

E4. APPLICATION FOR CONSTRUCTION WORK PERMIT

Where the contract meets the requirements of Construction Regulation 3, the Employer must at least 30 days before commencement of the work and in accordance with the requirements of Construction Regulation 3, apply to the Provincial Director of the Department of Labour in writing for a construction work permit to perform construction work. The Employer's application must be done in a form similar to Annexure 1 of the Construction Regulations, and submitted with the required documentation, some of which the Contractor shall provide as stated in the Contract Data.

A copy of the construction work permit must be kept on site in the occupational health and safety file, available for inspection by inspectors, the Employer, the Employer's Agent, the Construction Health and Safety Agent, subcontractors, employees, representative trade unions and any other persons on the site. The Provincial Director will assign a site-specific number for each construction site, which must be conspicuously displayed at the main entrance to the site.

E5. NOTIFICATION OF CONSTRUCTION WORK

Where the contract meets the requirements of Construction Regulation 4, the Contractor shall, before commencement of the work and in accordance with the requirements of Construction Regulation 4, notify the Provincial Director of the Department of Labour of the intention to carry out the construction work, using the pro forma form included as Annexure 2 to this Health and Safety Specification.

A copy of the notification form must be kept on site, available for inspection by inspectors, the Employer, the Employer's Agent, the Construction Health and Safety Agent, subcontractors, employees, representative trade unions and any other persons on the site. A copy of the notification form shall also be kept on the health and safety file, and a further copy shall be forwarded to the Employer for his records.

E6. HEALTH AND SAFETY PLAN

Before commencement of any construction work, the Contractor shall prepare a project specific Health and Safety Plan complying with the requirements of Construction Regulation 7(1)(a) and this Health and Safety Specification.

The Health and Safety Plan must include a risk assessment performed and recorded in writing by a competent person as required in terms of Construction Regulation 9. The risk assessment shall identify and evaluate the risks and hazards that may be expected during the execution of the work under the contract, and it shall include a documented plan and applicable safe work procedures to mitigate, reduce or control the risks and hazards identified.

The Health and Safety Plan shall be available on site for inspection by inspectors, the Employer, the Employer's Agent, subcontractors, employees, representative trade unions, and health and safety representatives and committee members, and must be monitored and reviewed periodically by the Contractor.

E7. APPOINTMENT OF EMPLOYEES AND SUBCONTRACTORS

E7.1 Appointments

The Contractor shall appoint in writing all employees.

The Contractor shall appoint in writing all subcontractors, and such appointments shall be in compliance with the requirements of Construction Regulation 7.

E7.2 Health and safety induction training

No person shall be allowed or permitted to enter the site of the works unless such person has undergone health and safety induction training pertaining to the hazards prevalent on the site.

The Contractor shall ensure that all employees under his control, including subcontractors and their employees, undergo health and safety induction training by a competent person before commencement of construction work in compliance with Construction Regulations 7(5) and 9(3) and (4).

The Contractor shall ensure that all visitors to the construction site undergo health and safety induction and are provided with the necessary personal protective equipment in compliance with Construction Regulation 7(6).

E7.3 Medical certificate of fitness

The Contractor shall ensure that every employee, including subcontractors and their employees, has a valid medical certificate of fitness issued in compliance with Construction Regulation 7(1)(g) or 7(8) as applicable.

E8. APPOINTMENT OF SAFETY PERSONNEL

E8.1 Construction manager

Refer to Construction Regulation 8(1), (2), (3) and (4).

The Contractor shall appoint a full-time **Construction Manager** with the duty of managing all the construction work on the site, including the duty of ensuring occupational health and safety compliance.

The Contractor may also have to appoint one or more **assistant construction managers** to assist the Construction Manager where justified by the scope and complexity of the works.

E8.2 Construction health and safety officer

Refer to Construction Regulation 8(5) and (6).

Taking into consideration the size of the project and the dangers, hazards or risks that can be expected, the Contractor shall appoint in writing a full-time or part-time **construction health and safety officer** to assist in the control of all health and safety related aspects on the site. The construction health and safety officer shall be registered as required by the Chief Inspector of the Department of Labour and shall have the necessary competencies and resources to assist the Contractor.

E8.3 Construction supervisor

Refer to Construction Regulation 8(7), (8), (9) and (10).

The Contractor shall appoint a **construction supervisor** responsible for construction activities and ensuring occupational health and safety compliance on the construction site.

The Contractor may also have to appoint one or more competent employees to assist the construction supervisor where justified by the scope and complexity of the works.

E8.4 Health and safety representatives

In terms of Sections 17 and 18 of the Act (OHSA 1993) the Contractor, being the employer in terms of the Act for the execution of the contract, shall appoint a **health and safety representative** whenever he has more than 20 employees in his employment on the site of the works. The health and safety representative must be selected from employees who are employed in a full-time capacity at a specific workplace.

The number of health and safety representatives for a workplace shall be at least one for every 50 employees.

The function of health and safety representative(s) will be to review the effectiveness of health and safety measures, to identify potential hazards and major incidents, to examine causes of incidents (in collaboration with his employer, the Contractor), to investigate complaints by employees relating to health and safety at work, to make representations to the employer (Contractor) or inspector on general matters affecting the health and safety of employees, to inspect the workplace, plant, machinery, etc. on a regular basis, to participate in consultations with inspectors and to attend meetings of the health and safety committee.

E8.5 Health and safety committee

In terms of Section 19 of the Act (OHSA 1993), the Contractor (as employer) shall establish one or more **health and safety committees** where there are two or more health and safety representatives at a workplace. The persons selected by the Contractor to serve on the committee shall be designated in writing.

The function of the health and safety committee shall be to hold meetings at regular intervals but at least once every three months, to review the health and safety measures on the contract, to discuss incidents related to health and safety with the Contractor and the inspector, to make recommendations regarding health and safety to the Contractor and to keep record of recommendations and reports made by the committee.

E8.6 Competent persons

The Contractor shall appoint in writing designated competent employees and/or other competent persons as required by the Act and Regulations. Such appointments shall be in accordance with the relevant applicable sections of the Act and Regulations as determined by the requirements of the contract.

A competent person may be appointed for more than one part of the construction work with the understanding that the person must be suitably qualified and able to supervise at the same time the construction work in all the work situations for which he has been appointed.

The appointment of competent persons to supervise parts of the construction work does not relieve the Contractor from any of his responsibilities for compliance with **all** requirements of the Construction Regulations.

E9. RECORDS AND REGISTERS

The Contractor shall keep records and registers related to health and safety on site as required by the relevant applicable sections of the Act and Regulations as determined by the requirements of the contract. Such records and registers shall be available for periodic inspection by inspectors, the Employer, the

Employer's Agent, the Construction Health and Safety Agent, subcontractors, employees and representatives of trade unions.

E10. CONTRACTOR'S RESPONSIBILITIES

For this contract the Contractor will be the mandatary of the Employer (Client), as defined in the Act (OHSA 1993), which means that the Contractor has the status of employer in his own right in respect of the contract. The Contractor is therefore responsible for all the duties and obligations of an employer as set out in the Act (OHSA 1993) and the Construction Regulations 2014.

Before commencement of work under the contract, the Contractor shall enter into an agreement with the Employer (Client) in terms of C1.4 'Agreement in terms of Section 37(2) of the Occupational Health and Safety Act No. 85 of 1993', to confirm his status as mandatary (employer) for the contract under consideration.

The Contractor is advised in his own interest to make a careful study of the Act and the Construction Regulations, as ignorance of the Act and the Regulations will not be accepted in any proceedings related to non-conformance to the Act and the Regulations.

E11. MEASUREMENT AND PAYMENT

It is a condition of this contract that contractors who submit tenders for this contract shall make provision in their various tendered rates and prices for all costs related to the health and safety measures required in terms of the Act and Regulations during the construction process.

(a) Health and safety plan

The Contractor shall assess the risks associated with the Works when preparing the health and safety plan. In addition, the Contractor shall implement the health and safety plan, including the provision of a dedicated, full time health and safety officer, carrying out all the required site health and safety training and briefings, staff medical evaluations, monitoring and administrating the health and safety plan and for supplying all transport, personal protection safety items, other health and safety equipment, safety notices and any other health and safety related items that are required on site. Provision is made for the costs of preparing and implementing the health and safety plan in item B13.03 of the Bill of Quantities.

(b) Safety appointments

No separate additional payment will be made to cover the costs related to persons appointed as required in terms of the Act and Regulations to fulfil the various health and safety functions. Such persons include the Construction Manager, any assistant construction managers, the construction health and safety officer, the construction supervisor, any assistant construction supervisors, health and safety representatives, health and safety committee members and competent persons, all as referred to in subclauses E8.1 to E8.6 above. The Contractor shall therefore make provision in the various tendered rates and prices for all costs related to such persons, and for which no separate additional payment will be made except to the extent provided in item B13.03 of the Bill of Quantities.

(c) Records and registers

The keeping of records and registers related to health and safety on site as described in clause E9 above shall be regarded as a normal duty of the Contractor for which payment shall be deemed to be included in the Contractor's various tendered rates and prices, and for which no separate additional payment will be made except to the extent provided in item B13.03 of the Bill of Quantities.

(d) Medical certificates

No separate additional payment will be made to cover the costs related to obtaining the medical certificates of fitness required for every employee, including subcontractors and their employees, issued in compliance with Construction Regulation 7(1)(g) or 7(8) as applicable. The Contractor shall therefore make provision in the various tendered rates and prices for all costs related to such medical certificates, and for which no

separate additional payment will be made except to the extent provided in item B13.03 of the Bill of Quantities.

ANNEXURE 2

**OCCUPATIONAL HEALTH AND SAFETY ACT, 1993
(Regulation 4 of the Construction Regulations, 2014)**

NOTIFICATION OF CONSTRUCTION WORK

1. (a) Name and postal address of principal contractor:
.....
.....
- (b) Name and telephone number of principal contractor's contact person:
.....
2. Principal contractor's compensation registration number:
.....
3. (a) Name and postal address of client:
.....
.....
- (b) Name and telephone number of client's contact person or agent:
.....
4. (a) Name and postal address of designer(s) for the project:
.....
.....
- (b) Name and telephone number of designer's(s') contact person(s):
.....
.....
5. Name and telephone number of principal contractor's construction manager on site appointed in terms of regulation 8(1):
.....
6. Name(s) of principal contractor's assistant construction manager(s) on site appointed in terms of regulation 8(2):
.....
.....
.....

ANNEXURE 2 - Continued

7. Exact physical address of the construction site or site office:

.....
.....
.....

8. Nature of the construction work:

.....
.....
.....

9. Expected commencement date:

10. Expected completion date:

11. Estimated maximum number of persons on the construction site:

Total: Male: Female:

12. Planned number of contractors on the construction site accountable to principal contractor:

.....

13. Name(s) of contractors already selected:

.....
.....
.....

.....
Principal Contractor **Date**

.....
Client's Agent (where applicable) **Date**

.....
Client **Date**

- THIS DOCUMENT IS TO BE FORWARDED TO THE OFFICE OF THE DEPARTMENT OF LABOUR **PRIOR TO COMMENCEMENT** OF WORK ON SITE.

C3.3 PARTICULAR SPECIFICATIONS

PART F: EXPANDED PUBLIC WORKS PROGRAMME

PART F: EXPANDED PUBLIC WORKS PROGRAMME

F1. SCOPE

This part provides the specifications with regard to the following:

- (a) The Expanded Public Works Programme (EPWP); and
- (b) The National Youth Service (NYS) programme, which is a government programme implemented by the National Department of Public Works forming part of the Expanded Public Works Programme (EPWP).

The Contractor shall be required to participate in job creation (employment of local labour) by executing various portions of the Works using local labour (unskilled or semi-skilled), recruited from the local community, who are South African Citizens or foreigners in possession of a work visa issued by the Department of Home Affairs (only one such foreigner may be employed on any project). Such local labour shall be the targeted participants in the EPWP and NYS programmes.

Furthermore, in order to avoid duplication of training facilities, the provision of training facilities for all structured training, including for the structured training described in Part G: Small Contractor Development (in those instances where Part G is included in the contract), shall be measured and paid for in terms of the pay items provided in this Part F.

F2. EXPANDED PUBLIC WORKS PROGRAMME (EPWP)

F2.1 Labour-intensive construction, supervision and management for the Expanded Public Works Programme (EPWP)

The Expanded Public Works Programme (EPWP) is a multi-sectoral government initiative to create jobs. In the case of the infrastructure sector, existing government expenditure is realigned using labour-intensive technologies to create job opportunities. This involves the use of both labour and construction equipment, where labour is preferred and construction equipment is used appropriately.

All work undertaken in terms of the Expanded Public Works Programme (EPWP) shall be implemented using labour-intensive construction methods to the extent economically feasible, in accordance with the "Guidelines for the Implementation of Labour-Intensive Infrastructure Projects under the Expanded Public Works Programme (EPWP) Third Edition 2015".

The aforementioned guidelines can be downloaded from the EPWP website of the Department of Public Works (<http://www.epwp.gov.za/>).

Items scheduled for labour-intensive construction are marked with the letters "LI" in the bill of quantities in the manner described in C2.1 Pricing Assumptions.

Contractors shall note that they shall employ in labour-intensive works only the following supervisory and management staff that have completed the required Skills Programme in terms of Appendix C of the aforementioned guidelines:

- (a) Foremen / Supervisors at NQF level 4 "National Certificate: Supervision of Civil Engineering Construction Processes";
- (b) Site Agent / Construction Manager at NQF level 5 "Manage Labour-Intensive Construction Processes" or equivalent Quality Council for Trades and Occupations (QCTO) qualifications at NQF level 5 or 7.

In addition to their normal supervisory and management functions, the aforementioned supervisory and management staff shall also be responsible for setting the workers' daily tasks in accordance with labour-intensive construction principles, and for ensuring that the EPWP job creation reporting data is accurately recorded on a daily basis and compiled and submitted to the Employer each month in accordance with clause F4 of this Part F.

F2.2 Labour laws applicable to the Expanded Public Works Programme (EPWP)

The work to be undertaken on this contract by unskilled or semi-skilled workers under the Expanded Public Works Programme (EPWP) shall be implemented in accordance with:

- (a) the Code of Good Practice for Employment and Conditions of Work for Expanded Public Works Programmes (EPWP), issued in terms of the Basic Conditions of Employment Act of 1997 by the Minister of Labour in Government Notice No. 129 of 18 February 2011 (Government Gazette No. 34032 of 18 February 2011); and
- (b) Ministerial Determination 4: Expanded Public Works Programmes, issued in terms of the Basic Conditions of Employment Act of 1997 by the Minister of Labour in Government Notice No. R347 of 4 May 2012.

The aforementioned Government Notice No. R347 contains the standard terms and conditions for workers employed in elementary occupations on an Expanded Public Works Programme (EPWP). These terms and conditions do not apply to persons employed in the supervision and management of an Expanded Public Works Programme (EPWP).

The above documents can be downloaded from the EPWP website of the Department of Public Works (<http://www.epwp.gov.za/>).

F2.3 Persons to be employed under the Expanded Public Works Programme (EPWP)

All local labour required for the execution of labour-intensive works shall be engaged strictly in accordance with prevailing legislation.

The Contractor shall, through the Project Liaison Committee (PLC) and with the assistance of the Community Liaison Officer (CLO), inform the local community of the labour-intensive works proposed and the employment opportunities thereby presented.

The Contractor shall determine the minimum education level / skills required to undertake the works specified. In consultation with the PLC and the War Room convener for each relevant ward, selection of the local labour shall be made from households on the Operation Sukuma Sakhe (OSS) database profiled through the War Room for each ward. The list obtained from the OSS database must be accompanied by a letter from the War Room convener confirming that all the information provided was sourced from the War Room and that all listed incumbents reside within the relevant ward. The Contractor must maintain records of household profiles as part of the portfolio of evidence for selection. Selection shall be based on the minimum education level / skills required and the most-needy households, as determined by the household profiling. Preference shall be given for at least one person from each household in the community to be employed before further persons are considered for selection.

The Contractor shall endeavour to ensure that the number of temporary jobs using local labour (unskilled or semi-skilled), recruited from the local community, who are South African Citizens or foreigners in possession of a work visa issued by the Department of Home Affairs (only one such foreigner may be employed on any project), shall include for a minimum allocation of:

- (a) 60% women;
- (b) 55% youth who are between the ages of 18 and 35; and
- (c) 2% persons with disabilities.

All labour recruitment, employment and associated risks shall remain the sole responsibility of the contractor.

The contractor shall comply with the minimum supervisor to worker ratio stated below, required to ensure the effective supervision of the labour-intensive works for all LI activities undertaken on this project:

Minimum supervisor to worker ratio = 1:10

F2.4 Contract of employment with persons employed under the Expanded Public Works Programme (EPWP)

The Contractor shall enter into a formal contract of employment with each person employed under the Expanded Public Works Programme (EPWP), using the pro forma contract of employment attached at the end of this Part F of section 3.3 Particular Specifications.

The Contractor shall note that all such formal contracts of employment entered into with persons employed under the Expanded Public Works Programme (EPWP) shall expire on 31 March each year, and the Contractor shall therefore be required to enter into new contracts with such persons as of 1 April each year.

F2.5 Employment of targeted labour under the Expanded Public Works Programme (EPWP)

The Contractor shall be contractually obliged to:

- (a) brief EPWP workers on the conditions of employment;
- (b) enter into a formal contract of employment with each EPWP worker, which contract will form part of the Employment Agreement;
- (c) keep personnel files for all EPWP workers and make copies available to the Employer if and when requested; and
- (d) ensure that payments to EPWP workers are made in accordance with Government Notice No. R347.

The rate of pay for persons employed under the Expanded Public Works Programme (EPWP) shall be the gazetted rate:

- (i) per task (for task-rated workers); or
- (ii) per day (for time-rated workers).

During those periods when an EPWP worker is engaged in formal classroom training (other than in-service training), the rate of pay shall be equal to the minimum wage rate as set on an annual basis in the Ministerial Determination for the Expanded Public Works Programme.

Tasks set by the Contractor shall be such that:

- (a) the average EPWP worker completes 5 tasks per week in 40 hours or less; and
- (b) the weakest EPWP worker completes 5 tasks per week in 55 hours or less.

The Contractor shall revise the time taken to complete a task whenever it is established that the time taken per week to complete the tasks set does not fall within the limits indicated in (a) and (b) above.

F2.6 Training of persons employed under the Expanded Public Works Programme (EPWP)

The training of persons employed under the Expanded Public Works Programme (EPWP) is described in clause F4 below.

F2.7 Contractor's obligations towards persons employed under the Expanded Public Works Programme (EPWP)

Over and above implementing in accordance with Government Notice Nos. 129 and R347 the EPWP work to be undertaken on this contract, it shall be the responsibility of the Contractor to carry out the following functions with respect to the EPWP workers:

- (a) ensure that all participants are covered by the Compensation for Occupational Injuries and Diseases Act, 1993, for as long as they are contracted to the Contractor, and pay in full to the Compensation Commissioner such amounts as are due in terms of the Act;

- (b) pay in full to the Unemployment Insurance Fund for all participants such UIF contribution amounts as are due in terms of the Unemployment Insurance Act, 2001, as amended, and the Unemployment Insurance Contributions Act, 2002, as amended, and provide proof of such UIF payments upon request;
- (c) ensure that all participants are paid their wages on time through the pre-agreed payment method as stipulated in the participant contract of employment;
- (d) implement health and safety procedures with respect to the participants, ensuring that the health and safety regulations are adhered to;
- (e) ensure that all participants receive induction on site safety prior to commencing with work on site;
- (f) provide all participants with the necessary protective clothing and equipment as required by law for the specific tasks in which the participants are involved, in addition to the branded overalls stipulated for EPWP workers;
- (g) provide safe on-site storage facilities for apparel and tools issued to the participants;
- (h) assist in the assessment of participants with regard to their competencies;
- (i) provide overall supervision and day-to-day management of participants; and
- (j) implement strict quality control to ensure that the work carried out by the participants is of the required standard, and, where necessary, to train and mentor the participants to assist them in achieving the standards required.

F2.8 Apparel and tools for persons employed under the Expanded Public Works Programme (EPWP)

The Contractor shall provide Personal Protective Equipment (PPE) to all EPWP workers in accordance with the requirements arising from Part E: OHS 1993 Health and Safety Specification and the Contractor's site-specific health and safety plan and accompanying risk assessments.

Where indicated below, certain items of the PPE issued by the Contractor to the EPWP workers shall include branded EPWP markings in accordance with the attached branding requirements.

PPE shall comprise the following:

- (a) Compulsory PPE issued to all EPWP workers for use during general work activities:
 - (i) Protective overalls (two sets), green in colour, with EPWP branding;
 - (ii) Lime green reflective safety vest with EPWP branding;
 - (iii) Protective footwear; and
 - (iv) Protective gloves.
- (b) PPE issued to EPWP workers for specific activities where required in terms of the Contractor's site-specific health and safety plan and accompanying risk assessments, such as:
 - (i) Protective headwear, green in colour, with EPWP branding;
 - (ii) Protective eyewear such as spectacles and goggles;
 - (iii) Protective face shields;
 - (iv) Protective earplugs and earmuffs;
 - (v) Respiratory masks;
 - (vi) Disposable safety apparel;
 - (vii) Kidney belts;
 - (viii) Safety harnesses; and
 - (ix) Any other protective equipment identified.

The Contractor shall replace any item of issued PPE that becomes unserviceable.

The Contractor shall not charge any fee to the EPWP workers for the prescribed PPE issued except under the following circumstances:

- (i) where the employee requests the issue of additional PPE in excess of what is prescribed;
- (ii) where the employee has patently abused or neglected the issued PPE leading to early failure; or

- (iii) where the employee has lost the issued PPE.

The Contractor shall instruct and train the EPWP workers in the use of all PPE issued, and shall ensure that they use the prescribed equipment.

EPWP workers shall not have the right to refuse to use or wear the equipment prescribed by the Contractor. If it is not possible for an EPWP worker, through health or any other reason, to use or wear the prescribed PPE issued, such employee shall not be allowed to continue working under the hazardous conditions for which the equipment was prescribed. Under such circumstances an alternative solution shall be found, and this may include relocating or discharging the employee.

The Contractor shall provide each EPWP worker with hand tools of adequate quality and of the type required to carry out the assigned tasks safely and efficiently.

The Contractor shall instruct and train the EPWP workers in the safe and efficient use of all hand tools issued.

The Contractor shall maintain the issued tools in a serviceable and safe working condition.

The EPWP workers shall be responsible for the safe on-site storage of all PPE and tools issued to them, using the storage facilities provided on site by the Contractor.

No separate payment shall be made for providing the EPWP workers with PPE, or for providing relevant items of PPE in the specified colours with branded EPWP markings. Furthermore, no separate payment shall be made for providing the EPWP workers with hand tools or for providing them with safe storage facilities on site for PPE and tools. The Contractor shall therefore make provision for all costs related to providing the PPE, tools and safe storage facilities in the tendered rates and prices for the various items of work scheduled throughout the bill of quantities.

F2.9 EPWP contract signboard

The Contractor will be required to erect a contract signboard displaying the EPWP logo, indicating that this project is part of the Expanded Public Works Programme (EPWP). Provision for the costs related to the provision, erection and subsequent removal of the contract signboard is made in pay item provided in chapter 1.3 of the bill of quantities for this purpose.

F2.10 Payment matters relating to the EPWP work

F2.10.1 General

No separate pay items shall be provided in terms of Part F of the bill of quantities for the construction work activities carried out by EPWP participants. Payment for such work activities shall be made only indirectly, in terms of the pay items scheduled for the work activities in which such persons are engaged.

Furthermore, no direct payment will be made to cover the Contractor's costs associated with implementing the on-site work programme for the EPWP participants, for planning, organising, directing, controlling and administrating their day to day activities, including the setting of daily tasks, record keeping and any on-site liaison, training and mentoring required, and for the associated job creation reporting, and such costs shall therefore be built into the rates tendered for the various items of work scheduled throughout the bill of quantities.

F2.10.2 Payment for labour-intensive components of the work

Payment will be made for items which are designated for labour-intensive construction in the bill of quantities only in those instances where such items are constructed using labour-intensive methods.

Any unauthorised use of construction equipment to carry out work which was scheduled to be carried out using labour-intensive methods will not be condoned and any Works so constructed will not be certified for payment. Any non-payment for such Works shall not relieve the Contractor in any way from his obligations either in contract or in delict.

During the course of construction, as a result of unforeseen site conditions or operating conditions encountered, it may happen that an item designated for labour-intensive construction can no longer be carried out in a safe and economically feasible manner, either in full or in part, using labour-intensive methods. In such instances the Employer's Agent shall, where necessary, order a variation in terms of clause 6.3 of the of the General Conditions of Contract 2015 with respect to that portion of the item quantity that cannot be carried out using labour-intensive methods.

F2.11 Penalty applicable to any shortfall in the local labour content achieved

The amount spent on wages for local labour (excluding VAT) for this project, as certified by the Employer's Agent, shall equal or exceed the specified minimum percentage of the contract amount which is the Contract Price (adjusted to exclude penalties and value added tax).

The Contractor is obliged to commit to or exceed the specified minimum percentage of local labour content stated in section C1.2.2 Data Provided by the Employer.

In the event that the Contractor fails to substantiate that any failure to achieve the minimum required local labour content for this project is due to quantitative underruns, the elimination of items contracted to local labour, or any other reason beyond the Contractor's control which may be acceptable to the Employer, the Contractor shall be liable for a financial penalty as prescribed in clause SCC 4.1.1 of section C1.2.1.2 Special Conditions of Contract. The financial penalty shall be calculated as follows:

$$P = 0,05 \times [(E - E_0)/100] \times C_A$$

where:

- E is the specified minimum percentage for local labour content
- E₀ is the local labour content percentage which the Employer's Agent certifies as being achieved upon completion of the contract
- C_A is the contract amount which is the Contract Price (adjusted to exclude penalties and value added tax)
- P is the monetary value of penalty payable

The penalty shall not apply to shortfalls in the allocations to the individual target groups (i.e., Women/Youth/Disabled as per clause F1.3 above), only to shortfalls in the total local labour content achieved.

The evaluation of the Contractor's achievement of the local labour content percentage shall be undertaken monthly by the Employer's Agent, based on the accumulative achievements in comparison to the programmed utilisation of local labour, as a means of monitoring the Contractor's performance in achieving the Contract Participation Goal.

Failure by the Contractor to achieve the Contract Participation Goal target by the time of Practical Completion, shall result in the financial penalty being applied as prescribed in this clause. The Employer's Agent shall make a final determination of the Contractor's achievement of the Contract Participation Goal based on the value of the Final Payment Certificate.

F3. NATIONAL YOUTH SERVICE (NYS)

Note: The Contractor shall not be required to employ NYS workers in terms of this contract.

The Employer requires the implementation of National Youth Service (NYS) programmes on this project.

F3.1 The National Youth Service (NYS) programme

The National Youth Service (NYS) programme aims to train young people and provide them with practical

work experience. The young people will be allocated tasks by the Contractor that will assist the Contractor with the execution of the contract.

F3.2 Applicable labour laws

The work to be undertaken on this contract by unskilled or semi-skilled workers under the National Youth Service (NYS) programme shall be implemented in accordance with the same Code of Good Practice and Ministerial Determination as described in clause F2.2 above for work to be undertaken under the Expanded Public Works Programme (EPWP).

F3.3 Employer's project manager

The Contractor shall be required to liaise closely with the Employer's project manager who is responsible for the recruitment and training of the NYS workers.

F3.4 Persons to be employed under the NYS programme

For purposes of this contract, the Contractor shall be required to employ 10 youths aged between 18 and 35 for a period of 6 months each under the NYS programme.

The Employer's project manager shall provide the Contractor with a list of the 10 youths to be employed and the training that each of these 10 youths have received to date, and only these 10 youths shall be employed by the Contractor under the NYS programme.

F3.5 Contract of employment with persons employed under the NYS programme

The Contractor shall enter into a formal contract of employment with each youth employed under the NYS programme, using the pro forma contract of employment attached at the end of this Part F of section 3.3 Particular Specifications.

F3.6 Employment of NYS workers

The Contractor will be contractually obliged to:

- (a) employ all participants on the list provided by the Employer's project manager;
- (b) brief NYS workers on the conditions of employment;
- (c) enter into a formal contract of employment with each NYS worker, which contract will form part of the Employment Agreement;
- (d) keep personnel files for all NYS workers and make copies available to the Employer's project manager if and when requested; and
- (e) ensure that payments to NYS workers are made in accordance with Government Notice No. R347.

During the period when they are engaged in formal classroom training (other than in-service training), the youths employed under the NYS programme shall be paid the minimum wage rate as set by the Department of Labour on an annual basis in the Ministerial Determination for the Expanded Public Works Programme, and should there be an upward adjustment in the rate the Contractor will be compensated accordingly. During the period when they are engaged in productive work activities required for elements of the Works, they shall be paid in terms of the wage rates stated in clause F2.5 above.

F3.7 Training of youth workers

All NYS workers will be placed on an extensive training programme that will include:

- (a) an induction into NYS and EPWP;
- (b) life skills training;
- (c) technical training focusing on a vocational skill to be used on the project (e.g. painting or carpentry); and
- (d) entrepreneurship and business skills training.

All training will be arranged by the Employer's project manager, with whom the Contractor will be required to

work closely to schedule the training sessions so that the timing of the training is aligned with the Contractor's work schedule and his demand for workers with specific skills. The Employer's project manager will make full details of the training programme available to the Contractor.

A compulsory 10-day life skills training must be provided before commencement of classroom training on NYS. This type of training must be provided by a NYDA accredited service provider as per the National Youth Service Framework from the National Department of Public Works.

The Contractor shall maintain comprehensive records of the training received by each NYS worker throughout the course of the contract, and shall submit to the Employer at each monthly site meeting a summary of the accumulated training received by each NYS worker.

The training of the NYS workers shall take place using the same training facility provided for the training of all other EPWP participants (refer to clause F5 below).

F3.8 Contractor's obligations towards persons employed under the NYS programme

Over and above implementing in accordance with Government Notice Nos. 129 and R347 the NYS programme work to be undertaken on this contract, it shall be the responsibility of the Contractor to carry out the following functions with respect to the NYS programme workers:

- (a) ensure that all participants are covered by the Compensation for Occupational Injuries and Diseases Act, 1993, for as long as they are contracted to the Contractor, and pay in full to the Compensation Commissioner such amounts as are due in terms of the Act;
- (b) pay in full to the Unemployment Insurance Fund for all participants such UIF contribution amounts as are due in terms of the Unemployment Insurance Act, 2001, as amended, and the Unemployment Insurance Contributions Act, 2002, as amended, and provide proof of such UIF payments upon request;
- (c) ensure that all participants are paid their wages on time through the pre-agreed payment method as stipulated in the participant contract;
- (d) implement health and safety procedures with respect to the participants, ensuring that the health and safety regulations are adhered to;
- (e) ensure that all participants receive induction on site safety prior to commencing with work on site;
- (f) provide all participants with the necessary protective clothing and equipment as required by law for the specific trades in which the participants are involved, in addition to the branded overalls stipulated for NYS workers;
- (g) provide safe on-site storage facilities for apparel and tools issued to the participants;
- (h) assist in the assessment of participants with regard to their competencies in their respective trades;
- (i) provide overall supervision and day-to-day management of participants; and
- (j) implement strict quality control to ensure that the work carried out by the participants is of the required standard, and, where necessary, to train and mentor the participants to assist them in achieving the standards required.

F3.9 Apparel and tools for NYS workers

The content of clause F2.8 above with regard to apparel and tools for EPWP workers shall apply equally to NYS workers, except that:

- (a) apparel and tools to be issued to NYS workers shall be determined in conjunction with the Employer's project manager;
- (b) the required branding of apparel to be issued to NYS workers shall be determined in conjunction with the Employer's project manager, and shall also include the NYS logo;
- (c) additional PPE may be required depending on the NYS worker's specific trade;
- (d) certain specified apparel and tools issued to the NYS workers will become the property of the NYS workers after the completion of their cycle of work on the project, in order to enable them to continue to practise their trade on future projects. Such apparel and tools shall be specified and authorised by the Employer's Agent; and
- (e) separate payment items have been provided in Part F of the bill of quantities to cover all costs

associated with the provision of the necessary tools and apparel, including safety apparel, for the NYS workers, and the facilities for the safe storage thereof, all as authorised by the Employer's Agent.

F3.10 EPWP-NYS contract signboard

Where work takes place under the National Youth Service (NYS) programme, the NYS logo shall also be displayed on the EPWP contract signboard referred to in clause F2.9 above, indicating that this project is part of both the Expanded Public Works Programme (EPWP) and the NYS programme. Provision for the costs related to the provision, erection and subsequent removal of the contract signboard in the pay item provided in chapter 1.3 of the bill of quantities for this purpose.

F3.11 Payment matters relating to the NYS work

No direct payment will be made to cover the Contractor's costs associated with implementing the on-site work programme for the NYS workers, for planning, organising, directing, controlling and administering their day to day activities, including the setting of daily tasks, record keeping and any on-site liaison, training and mentoring required, and for the associated job creation reporting, and such costs shall therefore be built into the rates tendered for the various items of work scheduled throughout the bill of quantities.

F4. JOB CREATION REPORTING FOR EPWP

In order to assist the Employer in complying with the goal of creating EPWP job opportunities, the Contractor must provide the information specified in clause F4.1 below for reporting purposes.

In addition, the Contractor's payment certificates shall be accompanied by the information specified in clause F4.2 below.

F4.1 Type of project data required per project

Every EPWP project shall collect and keep specific project data for the purpose of EPWP progress reporting on a monthly basis, using the EPWP Data Collection Tool template (this will be made available to the Contractor in Microsoft Excel format - refer to the pro forma spreadsheets at the end of this Part F of the Particular Specifications).

The data that is required to be kept, maintained and reported on a monthly basis for each project includes:

F4.1.1 Participant (local labour) data

A participant list of the local labour employed must be maintained for every EPWP project. The data required in this participant list is indicated below. This data shall be recorded, checked and signed off by the Contractor, and shall be submitted to the Employer at each monthly site meeting. The participant list shall contain the following data and shall be kept and maintained on site for audit purposes:

- (a) Participant identity – name, surname, initials, date of birth and identity number (or other unique identifier) plus certified copy of ID book.
- (b) Participant profiles – nationality, gender, age, education level and disability status.
- (c) Work data for participants – daily wage to be received, number of calendar days training attended and number of calendar days worked.
- (d) Records of training – as required in terms of the EPWP Data Collection Tool template.

In addition, the signed contracts of employment between the Contractor and each EPWP participant shall be kept and maintained on site for audit purposes.

F4.1.2 Project work data

The project work data generally seeks to confirm the number of people at work daily on the project. This data shall be recorded, checked and signed off by the Contractor, and shall be submitted to the Employer at

each monthly site meeting. The data shall be maintained on site by the Contractor, in order that it can be provided by the Employer to the National Department of Public Works upon request when the latter is undertaking sample auditing. These records shall be kept by the Contractor for a period of three years after contract completion should they be required for audit purposes.

The data shall include:

- (a) Daily attendance register – register for each day showing all the workers that were registered as being at work on that day. Attendance registers shall be completed on site on a daily basis and signed off by the Contractor on a weekly basis. Refer to pro forma attendance register attached at the end of this Part F of section 3.3.
- (b) Summary of monthly attendance.

F4.1.3 Project payment data

The project payment data generally seeks to confirm what was paid, for how much work and to whom. This data shall be recorded, checked and signed off by the Contractor, and shall be submitted to the Employer at each monthly site meeting.

It is required that the Contractor adopt one of the following methods as standard procedure for recording and maintaining this information:

- (a) Payment register – this is a list of the workers showing the wages paid to each worker, and signed off by each worker as proof of receipt and acceptance of payment. Information on this register must include the name of the worker, either an identity number or other unique identifier, the number of calendar days that the pay period covers, the wage rate and the total wages paid; or
- (b) Bank records showing the transfers to each worker account, signed off by the Contractor as proof of payment – these bank records must specifically show the name of the worker, either an identity number or other unique identifier, the period which the pay covers and the total wages paid.

The project payment data, as recorded and maintained by the Contractor in terms of either (a) or (b) above, must be available and applicable for the entire period for which the Employer claims an incentive reward for person-days of work created in terms of the project.

F4.1.4 Employment output data

The Contractor shall submit to the Employer at each monthly site meeting a progress report detailing production output compared to the programme of works, together with the data necessary to enable the Employer to calculate the following employment output data in accordance with the EPWP Data Collection Tool template:

- (a) Number of work opportunities created (where one work opportunity = paid work created for one individual on an EPWP project, for any period of time).
- (b) Number of person-days of work created (where one person-day = one day of work carried out by one individual). The total number of person-days of work created on a particular EPWP project shall be obtained by summing the total number of person-days worked by each individual employed during the course of that EPWP project.
- (c) Number of Full Time Equivalent (FTE) created (= total number of person-days of work created on the EPWP project divided by 230 working days). In terms of EPWP policy, one year of work created for one individual is assumed to comprise a total of 230 days of paid work carried out by that individual.
- (d) Average duration of work opportunities created (= total number of person-days of work created on the EPWP project divided by the number of work opportunities created on that EPWP project).
- (e) Average daily wage rates paid (= accumulated total of the wages paid to all individuals employed on an EPWP project divided by the total number of person-days of work created on that EPWP project).
- (f) Training information.

F4.2 Project data to be submitted with the Contractor's payment certificates

The Contractor's payment certificates shall be accompanied by labour returns providing the labour information for the corresponding period in a format specified by the Employer.

Should the Contractor choose to delay submitting payment certificates, the labour returns shall nevertheless still be submitted as per the frequency and timeframes stipulated by the Employer. The Contractor's payment certificates shall not be paid by the Employer until all pending labour information has been submitted.

The following information shall be maintained on site and submitted with each payment certificate in the format specified by the Employer:

- (a) Copies of the signed contracts between the Contractor and any new EPWP participants (the Contractor shall note that all such formal contracts of employment entered into with persons employed under the Expanded Public Works Programme (EPWP) shall expire on 31 March each year, and the Contractor shall therefore be required to enter into new contracts with such persons as of 1 April each year, and shall be required to submit copies of all such new contracts with the first payment certificate thereafter);
- (b) Certified ID copies of all local labour employed as EPWP participants;
- (c) Attendance registers for the EPWP participants;
- (d) Proof of payment of EPWP participants; and
- (e) Information as required in terms of the EPWP Data Collection Tool template.

F5. PROVISION OF STRUCTURED TRAINING

F5.1 Scope of structured training

In order to avoid duplication of training facilities, the training described in Part G: Small Contractor Development (in those instances where Part G is included in the contract), shall be provided utilising the training facility measured and paid for in accordance with the requirements of this Part F: Expanded Public Works Programme (EPWP).

The Employer's objectives include the training of local labour and Targeted Enterprises within a structured programme, in order to equip them with skills that will assist them in gaining future employment, and to facilitate targeted EPWP participants in gaining competencies and unit standard credits towards future full learnership qualifications.

Such training shall contain both theoretical and practical components and shall be conducted in accordance with the various laws and regulations contained in the South African Qualifications Authority (SAQA) statutes.

The following aspects of the structured training to be provided are noted:

- (a) The Employer has no service agreement or memorandum of understanding with any Education and Training Quality Assurance (ETQA) body, and therefore does not function as the employer as defined under any three-party learnership agreement between the learner, the training provider and the employer.
- (b) The structured training programmes implemented on this contract, although comprising several unit standards, are unlikely to total to sufficient credits for a full learnership qualification. Nevertheless, the competencies and credits achieved should contribute to a full learnership through the later acquisition by the learner of the remaining unit standards required for the full learnership.

The Contractor shall be required to provide a training facility on the Site, or in close proximity thereto, and to provide over the duration of the contract the following structured training for EPWP participants:

- (a) Generic skills training;
- (b) Entrepreneurial skills training;

- (c) Construction skills training; and
- (d) In-service training.

Generic skills training and in-service training shall be provided to all EPWP participants.

Entrepreneurial and construction skills training shall be provided to targeted EPWP participants only.

F5.2 Training provider and trainers

The Contractor shall be required to procure the services of a training provider accredited by the Construction Education and Training Authority (CETA).

The training provider shall have in its employ trainers who are registered as assessors with the Construction Education and Training Authority (CETA), and who shall deliver the training.

Proof of the accreditation of the service provider and the registration of the trainers by the CETA shall be submitted to the Employer's Agent. Such accreditation and registration shall be current and valid, and the proof submitted shall include the NQF levels and unit standards for which each trainer is accredited.

F5.3 Skills analysis and selection of targeted EPWP participants

Studying for any learnership requires minimum literacy and numeracy competencies as defined by SAQA. The actual literacy and numeracy levels of the persons employed on the Site shall provide a basis to guide the Contractor and the training provider on how to conduct the selection process.

The Contractor shall therefore conduct a skills analysis of the local labour and Targeted Enterprises employed, in order to determine the formal education qualifications of each employee.

The Contractor, in conjunction with the training provider, shall then identify those persons that display the potential to benefit from such structured entrepreneurial and construction skills training as may be provided for in the contract, and shall make recommendations in this regard to the Employer's Agent.

The final candidates selected for such training shall be decided between the Contractor and the Employer's Agent (or by the Project Management Team (PMT) in the case of training for Targeted Enterprises in terms of Part G: Small Contractor Development, where applicable).

F5.4 Structured training programmes

The Contractor, supported by the training provider, shall plan then implement structured training programmes for generic, entrepreneurial and construction skills training.

Training courses shall commence within four months of the Contractor taking possession of the Site, and shall be completed before the Due Completion Date.

All training shall take place within normal working hours, or as otherwise agreed with the learners.

The training provider shall design, compile and deliver the structured training programmes, based on the information obtained from the skills analysis.

F5.4.1 Generic skills training

The structured training programmes designed by the training provider for the generic skills training shall comprise relevant general courses such as basic hygiene and HIV/AIDS awareness, first aid, road safety, managing personal finance, and other courses that would be useful to workers in the road construction industry or as life skills generally.

F5.4.2 Entrepreneurial skills training

The structured training programmes designed by the training provider for the entrepreneurial skills training shall comprise unit standards that contribute towards one or more of the following full learnership qualifications, as appropriate taking into consideration the skills analysis information for the selected candidates (details of the learnership qualifications and the applicable unit standards may be found on the website www.saqa.org.za):

ENTREPRENEURIAL SKILLS TRAINING				
Qualification title	SAQA qualification ID	NQF level	Minimum credits	Purpose of qualification
National Certificate: Supervision of Construction Processes	49053	Level 4	176	Learners found competent against this qualification will be able to execute the supervision of construction processes, with specialisation in a specific context

F5.4.3 Construction skills training

The structured training programmes designed by the training provider for the construction skills training shall comprise unit standards that contribute towards one or more of the following full learnership qualifications, as appropriate taking into consideration the skills analysis information for the selected candidates (details of the learnership qualifications and the applicable unit standards may be found on the website www.saqa.org.za):

CONSTRUCTION SKILLS TRAINING				
Qualification title	SAQA qualification ID	NQF level	Minimum credits	Purpose of qualification
National Certificate: Supervision of Construction Processes	49053	Level 4	176	Learners found competent against this qualification will be able to execute the supervision of construction processes, with specialisation in a specific context
National Certificate: Construction: Roadworks	24173	Level 3	155	This qualification is for persons who work or intend to work within a construction context on a site, and who seek recognition for essential skills in construction operations in roadworks.
National Certificate: Construction: Roadworks	24133	Level 2	120	This qualification is for persons who work or intend to work within a construction context on a site, and who seek recognition for essential skills in construction operations in roadworks.
National Certificate: Occupational Health, Safety and Environment	74269	Level 2	120	This qualification is to equip learners working in any type of workplace with a broad understanding and knowledge of Occupational Health, Safety and Environmental (HSE) concepts and practices with sufficient detail to enable them to function in a safe and healthy way and to deal with health and safety problems and issues.

F5.4.4 Training programme

The Contractor's proposed training programmes shall be subject to the approval of the Employer's Agent (or the approval of the Project Management Team (PMT) in the case of training for Targeted Enterprises in terms of Part G: Small Contractor Development, where applicable), and the Contractor shall, if so instructed by the Employer's Agent or the PMT, alter or amend the programmes and the course content to meet any additional needs identified.

The Contractor shall be responsible for everything necessary for the delivery of the training programmes, including:

- (a) the provision of the trainers;

- (b) the provision of a suitable secure venue, complete with adequate furniture, lighting, air conditioning, power and ablution facilities;
- (c) the provision of all necessary stationery, consumables and study materials;
- (d) the transportation of the learners to and from the training facility;
- (e) the payment of wages to all learners during the classroom training at a rate equal to the minimum wage rate as set on an annual basis in the Ministerial Determination for the Expanded Public Works Programme;
- (f) the provision of any relevant Personal Protective Equipment (PPE) required for the training; and
- (g) additional supervision of the learners during the practical learning stage of the training carried out by constructing relevant elements of the Works (wages for the learners during this stage of the training will be paid through the rates tendered for the relevant scheduled work items for those elements).

At the successful completion of each course, the Contractor's training provider shall, as proof of attendance and completion, issue each learner with a certificate indicating the course content.

The training provider shall also ensure that each unit standard contributing towards a full learnership qualification and successfully completed by the learner is entered onto the national database.

The Contractor shall keep comprehensive records of the training given to each learner and the certificates issued, and shall provide copies of such records to the Employer's Agent when required.

The Contractor shall also complete and submit to the Employer's Agent each month, in a format acceptable to the Employer (using the EPWP Data Collection Tool template), a return detailing the training provided, both for the month and cumulatively for the contract.

F5.5 In-service training

The Contractor shall, from the commencement of the contract, implement an in-service training programme in which the various skills required for the execution and completion of the Works are imparted to the EPWP participants engaged thereon.

Throughout the duration of the contract, the EPWP participants shall be trained progressively through the various stages of each particular type of work in which they are engaged, and their work shall be supervised and monitored and their methods corrected where necessary.

The in-service training programme shall be submitted with the initial Works programme. The Contractor shall record the progress in relation to this programme on a monthly basis, and this progress report shall be incorporated in the monthly site meeting minutes and the payment certificate.

The Contractor shall provide sufficient skilled and competent trainers to train all EPWP participants engaged on the contract in the various skills required to enable them to carry out the required construction activities.

The in-service training of EPWP participants shall take place before commencement of the relevant construction activity, and the Contractor shall take into account in his programme the lead time required for such training. All in-service training shall be deemed to be an element of the relevant construction activity.

All formal in-service training shall be documented in terms of the EPWP Data Collection Tool template, and shall be accompanied by an attendance register of the EPWP participants on the applicable days.

All EPWP participants shall be remunerated at their agreed wage rate in respect of the time spent undergoing in-service training. The cost of the Contractor's in-service training obligations shall be deemed to be covered by the sums and rates tendered for items B13.01(a), (b) and (c) in the bill of quantities.

On termination of their employment, the Contractor shall provide each EPWP participant engaged on the contract with a certificate of service on which the following information shall be recorded:

- (i) name of the Contractor;
- (ii) name of the project / contract;
- (iii) name of the employee;

- (iv) nature of the work satisfactorily executed by the EPWP participant and the time spent thereon;
- (v) nature and extent of training provided to the EPWP participant; and
- (vi) dates of service.

F5.6 Training venue facility

The training venue facility to be provided by the Contractor shall be constructed, furnished and fully serviced for the duration of the contract in accordance with Chapter 1.4 of the Standard Specifications for Road and Bridge Works for South African Road Authorities (COTO), Draft Standard (DS), October 2020.

In order to minimise the cost of transporting the learners for training, the facility shall be located in secure premises on the Site, or in close proximity thereto.

This facility shall be used to deliver all training, irrespective of whether it is delivered in terms of Part E or Part F of the Particular Specifications.

The facility shall accommodate a class of up to 25 learners and shall comprise the following:

(a) Lecture room (interior area)	=	48 m ²
(b) Ablutions (male)	=	6 m ²
(c) Ablutions (female)	=	6 m ²
(d) Chairs for learners (individual chairs, with backs)	=	25 off
(e) Desk area for 25 learners (500 mm width)	=	12,5 m ²
(f) Chairs for trainers and management (individual chairs, with backs)	=	5 off
(g) Table area for trainers and management	=	3 m ²
(h) 220/250 volt power points	=	6 off
(i) Double 80 watt fluorescent light fittings complete with ballast and tubes	=	6 off
(j) Single incandescent light fittings complete with 100 watt globes	=	4 off
(k) Wash hand basins complete with taps and drains	=	4 off
(l) Fire extinguishers, 9,0 kg, all-purpose dry powder type, complete, mounted on wall with brackets	=	2 off
(m) Air conditioning units with 2,2 kW minimum capacity, mounted and with own power connection	=	4 off
(n) Voltage stabilizers	=	2 off
(o) Floodlights complete with poles and 500 watt minimum globes and controlled by photocells	=	2 off
(p) White boards (3 m x 1,5 m)	=	1 off
(q) Venetian blinds	=	12 m ²

F6. MEASUREMENT AND PAYMENT

Item	Unit
F6.01 Provision of the training venue facility, including the cost of transporting the learners to and from this facility	lump sum (Sum)

The tendered lump sum for subitem F6.01 shall include full compensation for the provision of the training venue facility complete and serviced as specified, including for the provision of power, water, sewerage and cleaning services for the duration of the contract, for lighting, power points and voltage stabilizers, for air conditioning, blinds, fire extinguishers, floodlights, furniture and whiteboards, for the provision of security at the facility, for all other costs necessary to maintain the facility for the duration of the contract, and for the removal of the facility on completion of the contract.

The tendered lump sum shall also include full compensation for transporting the learners on each day of training from their place of work to this training venue facility, and back again after the training for the day has been delivered by the accredited trainers.

Payment of the lump sum shall be made in three instalments as follows:

The first instalment, 50% of the lump sum, shall be paid after the Contractor has met all his obligations regarding the provision of the training venue facility, complete and serviced as specified, and the facility has been successfully commissioned for use.

The second instalment, 35% of the lump sum, shall be paid when 75% of the training courses proposed in accordance with the Contractor's approved structured training programme have been delivered to the learners by the accredited trainers.

The third and final instalment, 15% of the lump sum, shall be paid when all training has been concluded and the facility has been dismantled and removed from the site.

Item	Unit
F6.02 Training of learners employed by the contractor or by the Targeted Enterprise subcontractors:	
(a) Generic skills:	
(i) Training costs	provisional sum (Prov sum)
(ii) Handling costs and profit in respect of subitem F6.02(a)(i)	percentage (%)
(b) Entrepreneurial skills:	
(i) Training costs	provisional sum (Prov sum)
(ii) Handling costs and profit in respect of subitem F6.02(b)(i)	percentage (%)
(c) Construction skills:	
(i) Training costs	provisional sum (Prov sum)
(ii) Handling costs and profit in respect of subitem F6.02(c)(i)	percentage (%)
(d) Transportation and accommodation costs of selected learners only, while receiving off-site training:	
(i) Transportation and accommodation costs	provisional sum (Prov sum)
(ii) Handling costs and profit in respect of subitem F6.02(d)(i)	percentage (%)

Expenditure under subitems F6.02(a)(i), (b)(i), (c)(i) and (d)(i) shall be in accordance with clause 6.6 of the General Conditions of Contract 2015.

The provisional sum for each of subitems F6.02(a)(i), (b)(i) and (c)(i) is provided to cover the total costs of the required training in generic, entrepreneurial and construction skills respectively, including for the procurement of the services of the accredited trainers and their delivery of the training courses to the learners, the provision of all training materials including all stationery and study materials, the wages of the learners for the duration of the courses including the associated COIDA and UIF payments, and the provision of any tools and PPE that may be required during those courses incorporating practical training modules. The payment of wages to learners in terms of subitems F6.02(a)(i), (b)(i) and (c)(i) will only be made to those learners who attend and successfully complete each course of the approved training programme. Payment shall not be made to learners who, once selected, do not attend or only partially complete structured training courses.

The tendered percentage for each of subitems F6.02(a)(ii), (b)(ii) and (c)(ii) is the percentage of the amount actually spent under each of subitems F6.02(a)(i), (b)(i) and (c)(i) respectively, and shall include full compensation for the handling costs of the Contractor and the profit in connection with the provision of the training in generic, entrepreneurial and construction skills respectively, including for the costs of record

keeping and reporting with respect to the training received by each learner.

The provisional sum for subitem F6.02(d)(i) is provided to cover all costs related to the transportation and accommodation costs of selected learners only, while receiving off-site training, where such learners have been specifically selected to receive such off-site training and where such training cannot be delivered using the training venue facility provided by the Contractor in terms of subitem F6.01.

The tendered percentage for subitem F6.02(d)(ii) is the percentage of the amount actually spent under subitem F6.02(d)(i), and shall include full compensation for the handling costs of the Contractor and the profit in connection with the transportation and accommodation costs of selected learners only, while receiving off-site training.

Item	Unit
F6.03	Payments associated with the NYS programme:
(a)	Employment of NYS workers provisional sum (Prov sum)
(b)	Provision of tools and apparel for the NYS workers provisional sum (Prov sum)
(c)	Handling costs and profit in respect of subitems F6.03(a) and (b) percentage (%)
(d)	Training of NYS workers:
(i)	Provision of training for NYS workers provisional sum (Prov sum)
(ii)	Handling costs and profit in respect of subitem F6.03(d)(i) percentage (%)
(e)	Liaison with the Employer's project manager and the training service provider:
(i)	Liaison conducted by the Construction Manager hour (h)
(ii)	Liaison conducted by the senior site foreman hour (h)

The provisional sums provided under subitems F6.03(a) and (b) shall be expended in accordance with clause 6.6 of the General Conditions of Contract 2015.

The provisional sum under subitem F6.03(a) shall be used to cover the cost of employment payments made by the Contractor to the NYS workers, including the associated COIDA and UIF payments, all as authorised by the Employer's Agent.

The provisional sum under subitem F6.03(b) shall be used to cover all costs associated with the provision of the necessary tools and apparel, including safety apparel, for the NYS workers, and the facilities for the safe storage thereof, all as authorised by the Employer's Agent.

The tendered percentage under subitem F6.03(c) is a percentage of the total amount of expenditure approved by the Employer's Agent under the provisional sum subitems F6.03(a) and (b), and shall include full compensation for attendance by the Contractor, for the handling costs of the Contractor, and for the profit in connection with payments made by the Contractor with respect to the NYS programme implementation.

The provisional sum provided under subitem F6.03(d)(i) shall be expended in accordance with clause 6.6 of the General Conditions of Contract 2015.

The provisional sum under subitem F6.03(d)(i) shall be used to cover all costs associated with the provision of training for the NYS workers, including the cost of procuring the services of the accredited trainers and their delivery of the training courses to the NYS workers, and the provision of all training materials including all stationery and study materials.

The tendered percentage under subitem F6.03(d)(ii) is a percentage of the total amount of expenditure approved by the Employer's Agent under the provisional sum subitem F6.03(d)(i), and shall include full compensation for attendance by the Contractor, for the handling costs of the Contractor, and for the profit in connection with payments made by the Contractor with respect to the provision of training for the NYS workers, including for the costs of record keeping and reporting with respect to the training received by each NYS worker.

The unit of measurement for subitems F6.03(e)(i) and (ii) shall be the hour. The tendered rates shall include full compensation for all costs related to the Construction Manager and the senior site foreman respectively for time spent at formal liaison meetings authorised and convened by the Employer's Agent for the specific purpose of liaising with the Employer's project manager and / or the training service provider. The payment shall be made only for the time spent in the formal meeting itself. No payment shall be made for time spent during any other on-site liaison, telephonic liaison, e-mail or written correspondence liaison between these parties, or for liaison conducted with the Employer's project manager and / or the training service provider by any other member of the Contractor's site staff or head office personnel, the cost of all of which shall be deemed to be included in the Contractor's time-related obligations under subitem B13.01(c).

Expanded Public Works Programme: PPE BRANDING For EPWP Projects



T-Shirt/Overall/Safety Vest Branding

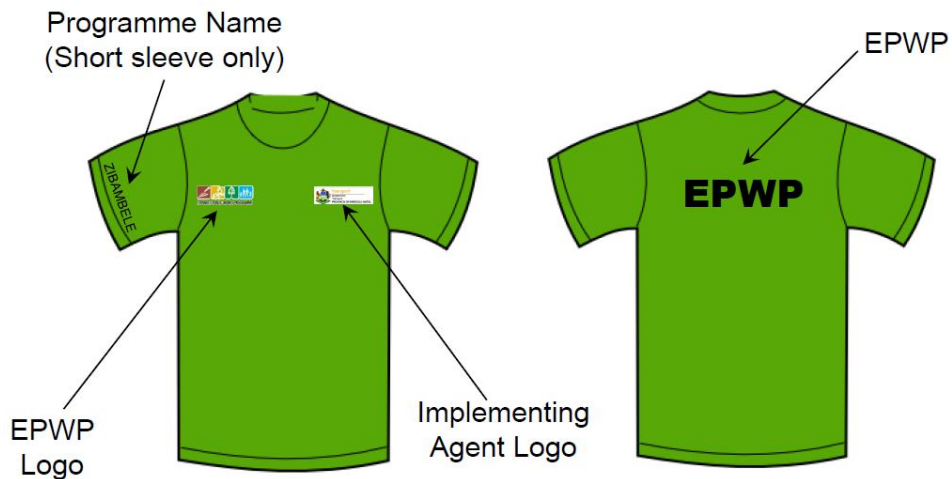

Logo Options

Implementing Agent Examples

National Projects

Provincial Department Projects

Municipal Projects

PLEASE VERIFY WHICH LOGO NEEDS TO USED

EPWP LOGO

The Logo shall not be disproportionately stretched. A monochrome black logo may be used on approval only.

The above logo is the current logo. Logos with green text below the words EXPANDED PUBLIC WORKS PROGRAMME are old logos and should not be utilised.

Printing on PPE

PPE (Overalls) shall be Pantone Green with/without reflective tape and shall be branded as follows:

- Implementer's Logo (printed or embroidered) on the left front pocket location ie over the heart position. (full colour)
- EPWP logo on the right front pocket (printed or embroidered) location (full colour)
- The letters EPWP on the back of the PPE in BLACK
- The program name eg Vuk'uphile is to be printed on the right sleeve of short sleeved apparel and need not be placed on long sleeved apparel.
- Where required, lime green safety vests are to be branded with similar specification above. In this instance the Overalls may not necessarily be branded provided that the use of high visibility vests is mandatory.
- All artwork and PPE samples shall be approved and signed off by the consultant prior to printing/embroidering.



Project Signboard

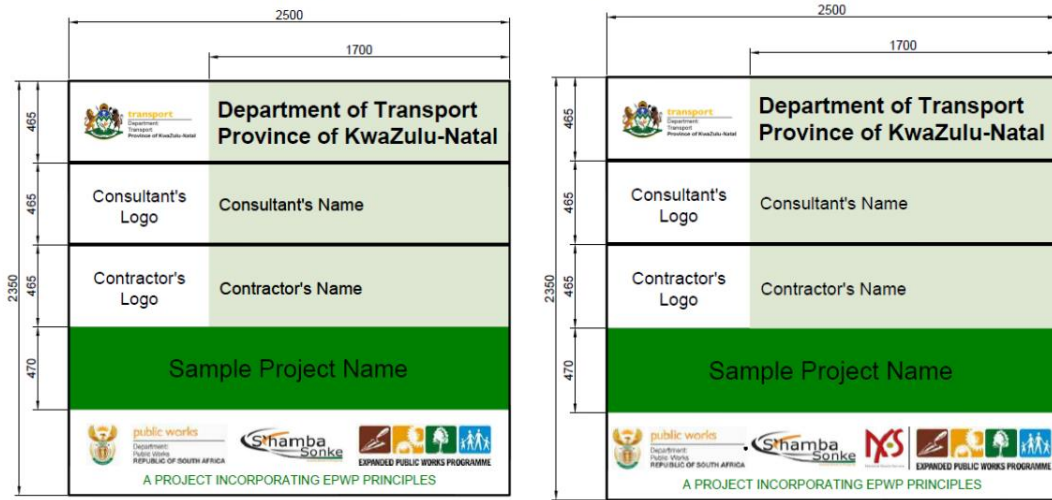

For further information contact:

Petronella Sithebe

Petronella.Sithebe@Kzntransport.gov.za

033-355-8023



PRO FORMA EPWP CONTRACT OF EMPLOYMENT

Contractor's
Logo



EXPANDED PUBLIC WORKS PROGRAMME

This contract must be read in conjunction with the standard terms and conditions of employment on EPWP attached herein.

EPWP CONTRACT OF EMPLOYMENT between

Employer Details

Name	Click or tap here to enter text.	Address	Click or tap here to enter text.
Telephone	Click or tap here to enter text.		
Email	Click or tap here to enter text.		
Contact	Click or tap here to enter text.		

And

Employee Details

Name	Click or tap here to enter text.	Surname	Click or tap here to enter text.
ID:	Click or tap here to enter text.	Cell	Click or tap here to enter text.
Sex (M/F)	Male <input type="checkbox"/> Female <input type="checkbox"/>	Disability	Yes <input type="checkbox"/> No <input type="checkbox"/>
Primary Language	Click or tap here to enter text.	Physical Address	Click or tap here to enter text.
Other Languages	Click or tap here to enter text.		
Highest Education Level Achieved	Click or tap here to enter text.	Local Municipality	Click or tap here to enter text.
Other qualifications	Click or tap here to enter text.	Ward	Click or tap here to enter text.
Grant Received (Y/N)	Yes <input type="checkbox"/> No <input type="checkbox"/>	Grant type:	

Employment Details

Name of project:	Click or tap here to enter text.		
Job Title:	Click or tap here to enter text.		
Duties:	Click or tap here to enter text.		
Contract Start Date	Click or tap here to enter text.	Contract Finish Date	Click or tap here to enter text.
The wage per task/day is:	R Click or tap here to enter text. / Hour/Day/task <i>(Specifier to select correct rate)</i>		

Special Conditions

<p>You must be aware that this employment contract is a limited term contract and not a permanent job. This employment contract may be terminated for any one of the following reasons:</p> <ul style="list-style-type: none"> a) The contractor does not get additional contracts from the EPWP. b) Funding for the programme in your area comes to an end. c) Underperformance: first offence – final written warning. Second offence – dismissal. 	<p>Payment</p> <ul style="list-style-type: none"> a) You will be paid a fixed amount stipulated above for completing a fixed amount of work. b) The amount of work required for the agreed rate of pay will vary from task to task. You will be informed at the beginning of each task or group of tasks how much work you are expected to complete per day. c) You will only be paid for work completed. d) Payment during classroom training shall be R /day
<p>Personal Protective Clothing will be supplied to the employee by the employer depending on the work to be performed, and will remain the property of the employee provided that the employee has worked for at least 3 months.</p>	

Acceptance

Employer Name:	Employer Signature:	Employee Name:	Employee Signature:
Witness 1 Name:	Witness 1 Signature:	Witness 2 Name:	Witness 2 Signature:

APPENDIX E – Conditions of Service

1. Introduction

1.1. This document contains the standard terms and conditions for workers employed in elementary occupations on an Expanded public Works Programme (EPWP). These terms and conditions do NOT apply to persons employed in the supervision and management of an EPWP.

1.2. In this document –

- a) “department” means any department of the State, implementing agent or contractor;
- b) “employer” means any department, implementing agency or contractor that hires workers to work in elementary occupations on an EPWP;
- c) “worker” means any person working in an elementary occupation on an EPWP;
- d) “elementary occupation” means any occupation involving unskilled or semi-skilled work;
- e) “management” means any person employed by a department or implementing agency to administer or execute an EPWP;
- f) “task” means a fixed quantity of work;
- g) “task-based work” means work in which a worker is paid a fixed rate for performing a task;
- h) “task-rated worker” means a worker paid on the basis of the number of tasks completed;
- i) “time-rated worker” means a worker paid on the basis of the length of time worked.

2. Terms of Work

- 2.1. Workers on an EPWP are employed on a temporary basis.
- 2.2. A worker may NOT be employed for longer than 24 months in any five-year cycle on an EPWP.
- 2.3. Employment on an EPWP does not qualify as employment as a contributor for the purposes of the Unemployment Insurance Act 30 of 1966.

3. Normal Hours of Work

- 3.1. An employer may not set tasks or hours of work that require a worker to work–
 - a) more than forty hours in any week
 - i. on more than five days in any week; and
 - ii. for more than eight hours on any day.
- 3.2. An employer and worker may agree that a worker will work four days per week. The worker may then work up to ten hours per day.
- 3.3. A task-rated worker may not work more than a total of 55 hours in any week to complete the tasks allocated (based on a 40-hour week) to that worker.

4. Meal Breaks

- 4.1. A worker may not work for more than five hours without taking a meal break of at least thirty minutes duration.
- 4.2. An employer and worker may agree on longer meal breaks.
- 4.3. A worker may not work during a meal break. However, an employer may require a worker to perform duties during a meal break if those duties cannot be left unattended and cannot be performed by another worker. An employer must take reasonable steps to ensure that a worker is relieved of his or her duties during the meal break.
- 4.4. A worker is not entitled to payment for the period of a meal break. However, a worker who is paid on the basis of time worked must be paid if the worker is required to work or to be available for work during the meal break.

5. Special Conditions for Security Guards

- 5.1. A security guard may work up to 55 hours per week and up to eleven hours per day.
- 5.2. A security guard who works more than ten hours per day must have a meal break of at least one hour or two breaks of at least 30 minutes each.

6. Daily Rest Period

Every worker is entitled to a daily rest period of at least eight consecutive hours. The daily rest period is measured from the time the worker ends work on one day until the time the worker starts work on the next day.

7. Weekly Rest Period

Every worker must have two days off every week. A worker may only work on their day off to perform work which must be done without delay and cannot be performed by workers during their ordinary hours of work (“emergency work”).

8. Work on Sundays and Public Holidays

- 8.1. A worker may only work on a Sunday or public holiday to perform emergency or security work.
- 8.2. Work on Sundays is paid at the ordinary rate of pay.
- 8.3. A task-rated worker who works on a public holiday must be paid –
 - a) the worker’s daily task rate, if the worker works for less than four hours;
 - b) double the worker’s daily task rate, if the worker works for more than four hours.
- 8.4. A time-rated worker who works on a public holiday must be paid –
 - a) the worker’s daily rate of pay, if the worker works for less than four hours on the public holiday;
 - b) double the worker’s daily rate of pay, if the worker works for more than four hours on the public holiday.

9. Sick Leave

- 9.1. Only workers who work four or more days per week have the right to claim sick-pay in terms of this clause.
- 9.2. A worker who is unable to work on account of illness or injury is entitled to claim one day’s paid sick leave for every full month that the worker has worked in terms of a contract.
- 9.3. A worker may accumulate a maximum of twelve days’ sick leave in a year.
- 9.4. Accumulated sick-leave may not be transferred from one contract to another contract.
- 9.5. An employer must pay a task-rated worker the worker’s daily task rate for a day’s sick leave.
- 9.6. An employer must pay a time-rated worker the worker’s daily rate of pay for a day’s sick leave.
- 9.7. An employer must pay a worker sick pay on the worker’s usual payday.
- 9.8. Before paying sick-pay, an employer may require a worker to produce a certificate stating that the worker was unable to work on account of sickness or injury if the worker is –
 - a) absent from work for more than two consecutive days; or
 - b) absent from work on more than two occasions in any eight-week period.
- 9.9. A medical certificate must be issued and signed by a medical practitioner, a qualified nurse or a clinic staff member authorised to issue medical certificates indicating the duration and reason for incapacity.
- 9.10. A worker is not entitled to paid sick-leave for a work-related injury or occupational disease for which the worker can claim compensation under the Compensation for Occupational Injuries and Diseases Act.

Employer	Employee
----------	----------

10. Maternity Leave

- 10.1. A worker may take up to four consecutive months' unpaid maternity leave.
- 10.2. A worker is not entitled to any payment or employment-related benefits during maternity leave.
- 10.3. A worker must give her employer reasonable notice of when she will start maternity leave and when she will return to work.
- 10.4. A worker is not required to take the full period of maternity leave. However, a worker may not work for four weeks before the expected date of birth of her child or for six weeks after the birth of her child, unless a medical practitioner, midwife or qualified nurse certifies that she is fit to do so.
- 10.5. A worker may begin maternity leave –
 - a) four weeks before the expected date of birth; or
 - b) on an earlier date –
 - i. if a medical practitioner, midwife or certified nurse certifies that it is necessary for the health of the worker or that of her unborn child; or
 - ii. if agreed to between employer and worker; or
 - iii. on a later date, if a medical practitioner, midwife or certified nurse has certified that the worker is able to continue to work without endangering her health.
- 10.6. A worker who has a miscarriage during the third trimester of pregnancy or bears a stillborn child may take maternity leave for up to six weeks after the miscarriage or stillbirth.
- 10.7. A worker who returns to work after maternity leave, has the right to start a new cycle of twenty-four months employment, unless the EPWP on which she was employed has ended.

11. Family responsibility leave

- 11.1. Workers, who work for at least four days per week, are entitled to three days paid family responsibility leave each year in the following circumstances -
 - a) when the employee's child is born;
 - b) when the employee's child is sick;
 - c) in the event of a death of –
 - i. the employee's spouse or life partner;
 - ii. the employee's parent, adoptive parent, grandparent, child, adopted child, grandchild or sibling.

12. Statement of Conditions

- 12.1. An employer must give a worker a statement containing the following details at the start of employment –
 - a) the employer's name and address and the name of the EPWP;
 - b) the tasks or job that the worker is to perform; and
 - c) the period for which the worker is hired or, if this is not certain, the expected duration of the contract;
 - d) the worker's rate of pay and how this is to be calculated;
 - e) the training that the worker will receive during the EPWP.
- 12.2. An employer must ensure that these terms are explained in a suitable language to any employee who is unable to read the statement.
- 12.3. An employer must supply each worker with a copy of these conditions of employment.

13. Keeping Records

- 13.1. Every employer must keep a written record of at least the following –
 - a) the worker's name and position;
 - b) in the case of a task-rated worker, the number of tasks completed by the worker;
 - c) in the case of a time-rated worker, the time worked by the worker;
 - d) payments made to each worker.
- 13.2. The employer must keep this record for a period of at least three years after the completion of the EPWP.

14. Payment

- 14.1. An employer must pay all wages at least monthly in cash or by cheque or into a bank account.
- 14.2. A task-rated worker will only be paid for tasks that have been completed.
- 14.3. An employer must pay a task-rated worker within five weeks of the work being completed and the work having been approved by the manager or the contractor having submitted an invoice to the employer.
- 14.4. A time-rated worker will be paid at the end of each month.
- 14.5. Payment must be made in cash, by cheque or by direct deposit into a bank account designated by the worker.
- 14.6. Payment in cash or by cheque must take place –
 - a) at the workplace or at a place agreed to by the worker;
 - b) during the worker's working hours or within fifteen minutes of the start or finish of work;
 - c) in a sealed envelope which becomes the property of the worker.
- 14.7. An employer must give a worker the following information in writing –
 - a) the period for which payment is made;
 - b) the numbers of tasks completed or hours worked;
 - c) the worker's earnings;
 - d) any money deducted from the payment;
 - e) the actual amount paid to the worker.
- 14.8. If the worker is paid in cash or by cheque, this information must be recorded on the envelope and the worker must acknowledge receipt of payment by signing for it
- 14.9. If a worker's employment is terminated, the employer must pay all monies owing to that worker within one month of the termination of employment.

15. Deductions

- 15.1. An employer may not deduct money from a worker's payment unless the deduction is required in terms of a law.
- 15.2. An employer must deduct and pay to the SA Revenue Services any income tax that the worker is required to pay.
- 15.3. An employer who deducts money from a worker's pay for payment to another person must pay the money to that person within the time period and other requirements specified in the agreement law, court order or arbitration award concerned.
- 15.4. An employer may not require or allow a worker to –
 - a) repay any payment except an overpayment previously made by the employer by mistake;
 - b) state that the worker received a greater amount of money than the employer actually paid to the worker; or
 - c) pay the employer or any other person for having been employed.

16. Health and Safety

- 16.1. Employers must take all reasonable steps to ensure that the working environment is healthy and safe.
- 16.2. A worker must –
 - a) work in a way that does not endanger his/her health and safety or that of any other person;
 - b) obey any health and safety instruction;
 - c) obey all health and safety rules of the EPWP;
 - d) use any personal protective equipment or clothing issued by the employer;
 - e) report any accident, near-miss incident or dangerous behaviour by another person to their employer or manager.

17. Compensation for Injuries and Diseases

Employer	Employee
----------	----------

- 17.1. It is the responsibility of the employers (other than a contractor) to arrange for all persons employed on an EPWP to be covered in terms of the Compensation for Occupational Injuries and Diseases Act, 130 of 1993.
- 17.2. A worker must report any work-related injury or occupational disease to their employer or manager.
- 17.3. The employer must report the accident or disease to the Compensation Commissioner.
- 17.4. An employer must pay a worker who is unable to work because of an injury caused by an accident at work 75% of their earnings for up to three months. The employer will be refunded this amount by the Compensation Commissioner. This does NOT apply to injuries caused by accidents outside the workplace such as road accidents or accidents at home.

18. Termination

- 18.1. The employer may terminate the employment of a worker for good cause after following a fair procedure.
- 18.2. A worker will not receive severance pay on termination.
- 18.3. A worker is not required to give notice to terminate employment. However, a worker who wishes to resign should advise the employer in advance to allow the employer to find a replacement.
- 18.4. A worker who is absent for more than three consecutive days without informing the employer of an intention to return to work will have terminated the contract. However, the worker may be re-engaged if a position becomes available for the balance of the 24-month period.
- 18.5. A worker who does not attend required training events, without good reason, will have terminated the contract. However, the worker may be re-engaged if a position becomes available for the balance of the 24-month period.

19. Certificate of Service

- 19.1. On termination of employment, a worker is entitled to a certificate stating –
 - a) the worker's full name;
 - b) the name and address of the employer;
 - c) the EPWP on which the worker worked;
 - d) the work performed by the worker;
 - e) any training received by the worker as part of the EPWP;
 - f) the period for which the worker worked on the EPWP;
 - g) any other information agreed on by the employer and worker.Either party can terminate this agreement with four weeks written notice. In the case where an employee is illiterate notice may be given by that employee verbally.

Employer	Employee
----------	----------

**EPWP DATA COLLECTION TOOL TEMPLATE
(PRO FORMAS OF MICROSOFT EXCEL SPREADSHEETS)**

EPWP REGISTRATION FORM		
Field requested	Description if needed	Please complete the sections in white
Project Details		
Profile ID	<i>Generated by the system</i>	
Project Name	<i>The name of the project</i>	
Project Reference Number	<i>Contract number</i>	
Project description	<i>Full description of what is happening in the project (as per the appointment letter) and the community benefiting from the project</i>	
Duration		
Project Start Date	<i>Planned Start date of the particular contract</i>	
Project End Date	<i>Planned End date of the particular contract</i>	
Estimated Budget	<i>Overall Contract budget (excluding professional fees) for Current Financial Year</i>	
Project Location		
Province	<i>In which province is the project implemented?</i>	KZN
District Municipality	<i>Under which District Municipality does this project falls?</i>	
Local Municipality	<i>Under which Local Municipality does this project falls?</i>	
Latitude (in decimal format)	<i>Is generated by the system</i>	
Longitude (in decimal format)	<i>Is generated by the system</i>	
Project Location per site		
Locality name	<i>Where exactly is the project implemented? (Ward name)</i>	
Subplace	<i>Town / Village</i>	
Ward	<i>The project site is located in which ward?</i>	
Government facility	<i>Landmark near the project (Post office/school/clinic/library)</i>	
Spatial Data Type	<i>Geopoint (structure)/ Line (road)/ Polygon(area)</i>	
Site physical address	<i>Physical address of the site office</i>	
Public Body Details		
Public body sphere	<i>In which sphere is the project implemented? (National, Provincial or Municipal)</i>	Provincial
Reporting public body that is the project owner (and will report on the project)	<i>Which Institution or Department that owns / approved this project (Education, Health, City of Tshwane Metro etc.)</i>	KZN Department of Transport
Department in the Public body that is responsible for the project	<i>Which department /unit is responsible for this project? (e.g. Roads & storm water, Education, Community safety etc.)</i>	KZN Department of Transport
Implementing public body type	<i>In which sphere is this project implemented? (Metro, Distr, Mun, National or Provincial Dept.)</i>	Provincial
Public body that will implement the project	<i>Which institution that implements the project?</i>	KZN Department of Transport
Project Implementation		
Is this the project on the municipal IDP	Yes / No	N/A
IDP reference number allocated to the project	<i>The number reflected in your Municipal IDP document</i>	N/A
EPWP Details		
EPWP Sector	<i>The project is implemented in which sector? (Infrastructure, Environment & culture, Non-state or Social)</i>	Infrastructure
EPWP Programme	<i>The project is implemented under which programme?</i>	
EPWP Sub Programme	<i>The project is implemented under which sub-programme?</i>	

EPWP BUSINESS FORM		
Field requested	Description if needed	Please complete the sections in white
Project Details		
Profile ID	<i>Generated by the system</i>	
Project Name	<i>The name of the project</i>	
Project Reference Number	<i>Contract number</i>	
Project description	<i>Full description of what is happening in the project (as per the appointment letter) and the community benefiting from the project</i>	
Duration		
Project Start Date		
Project End Date		
Estimated Budget	<i>Project Budget</i>	
Project Location		
Province		KZN
District Municipality	<i>Under which District Municipality does this projects falls</i>	
Local Municipality	<i>Under which Local Municipality does this projects falls</i>	
Latitude (in decimal format)	<i>GPS coordinates</i>	
Longitude (in decimal format)		
Public Body Details		
Public body sphere	<i>Such as Municipal or Provincial</i>	Provincial
Reporting public body that is the project owner (and will report on the project)	<i>Which Department approved the project in (education, Health etc.)</i>	KZN Department of Transport
Department / Unit in the Public body that is responsible for the project	<i>Which Department budgeted for the project e.g. Education, Health Directorate</i>	KZN Department of Transport
Implementing public body type	<i>Example(Local Municipality, Distr. Mun or Provincial Dept.</i>	Provincial
Public body that will implement the project	<i>Infrastructure, Environment or Social</i>	KZN Department of Transport
Is this project on the Municipal IDP	<i>Municipal projects</i>	N/A
IDP reference number allocated to the project		N/A

EPWP Details		
EPWP Sector	<i>The project is implemented in which sector? (Infrastructure, Environment & culture, Non-state or Social)</i>	Infrastructure
EPWP programme	<i>The project is implemented under which programme?</i>	
EPWP Sub Programme	<i>The project is implemented under which sub-programme?</i>	
Budget Amount-(Allocations for the project duration)		
Funding Body	<i>Which Dept. is funding the project</i>	KZN Department of Transport
Funding Year	<i>Financial year/s for the project</i>	
Total Budget Amount	<i>(Exclude Professional Fees)</i>	
Incentive Grant(e.g. landcare / EPWP grant)	<i>Grant funding received</i>	
Total wages paid for the duration of the projects	<i>What amount will be spent on wages during the duration of the project</i>	
Wage Rate	<i>Daily Wage rate to be paid during productive work</i>	
Stipend Rate	<i>Daily wage rate to be paid during training</i>	
UIF	<i>The amount being paid to UIF (if applicable)</i>	
COIDA	<i>The amount being paid to COIDA(if applicable)</i>	
Training	<i>What amount will be spent on training</i>	
Administration	<i>The Administration costs</i>	
Equipment and materials	<i>Budget for Materials and Equipment</i>	
Other	<i>If other where chosen describe the other Such as Professional fees)</i>	
Describe other		
Project Outputs and Training		
Planned Primary Output	<i>eg walkways, gabions, kerb * channel, km of road constructed</i>	
Description of Planned Primary Output	<i>Describe the project output (end product and not the milestone) (e.g. kms of tar road constructed) Start with the unit of measure such as number of, kms, ha, sqms etc</i>	
Unit of measure of primary output	<i>Eg. m, m², m³, km, no, ha etc</i>	
Planned primary output quantity	<i>Specify the quantity of output planned</i>	
Number of persons to be trained	<i>How many persons are targeted for on job training</i>	

Contact person		
Title	Person responsible for the Project in the Public Body (Project Manager)	
Initials		
First Name		
Surname		
Email		
Tel (Office)		
Fax Number		
Cell Number		
Physical Address 1		
Physical Address 2		
Physical Address 3		
Physical Address 4		
Postal Address 1		
Postal Address 2		
Postal Address 3		
Postal Address 4		
Position of person		

EPWP Monthly Progress Form		
Field requested	Description if needed	Please complete the sections in white
Project Details		
Profile ID	full descripton of what is happening in the project (as per the appointment letter) and the community benefiting from the project	
Project Name	The name of the project	
Project Reference Number	Contract number	
Project description	Full descripton of what is happening in the project (as per the appointment letter) and the community benefiting from the project	
Month		
Reporting Month		April
Budget Expenditure		
Cumulative Expenditure Amount	What is the Overall amount spend on this project?	
Current Expenditure Amount	What is the amount spend including all grants for this month?	
Wages	How much paid on wages for this month only?	
UIF	How much paid on UIF for this month only?	
COIDA	How much paid on COIDA for this month only?	
Stipends for training	Amount paid to participants whilst on training (this month only)	
Amount spent on service providers for training	How much paid to service providers for training for this month only?	
Training	Total Cost of training for this month? (number captured on ERS)	
Administration	How much paid on administration for this month only?	
Equipment and materials	How much paid on equipment and materials for this month only?	
Other	How much paid on other?	
Describe other	Be specific e.g. Consulting fees, Transport etc.	
Project output description	Describe the project output (end product and not the milestone) (e.g. kms of tar road constructed) Start with the unit of measure such as number of, kms, ha, sqms etc	
Unit of measure of primary output	Eg. m, m ² , m ³ , km, no, ha etc	
Cumulative primary output achieved	Since the onset of the project	
Quantity Achieved	enter numeric output for this month only	
Percentage achieved	How much work done / achieved in percentages?	
EPWP Branding		
Branding compliant	Yes / No	
Date that the branding was provided	When was the project branded?	
Has a photo of project branding been provided?	Yes / No	
First name of Official Who Branded Project	Official Name	
Surname of Official Who Branded Project	Official Surname	
Phone number of official who erected branding for the project	Official contact number	
Give the public body reference and name, and organisational details of the person that provided branding.	Public body details (reference & name)	

First Name	Initials	Surname	ID number	Date Of Birth	Wage Rate	Total Paid Days	Amount Paid	Work Days	Training Days Paid	Training Days Non Paid	Total Training Days	Training Course ID	Project Profile ID	Month	Year	Beneficiary Code



EXPANDED PUBLIC WORKS PROGRAMME

The Attendance Register for on-site Workers

Reporting month: _____

Mobile No: _____

Project Name: _____

Contract no: _____

Surname: _____

First Name: _____

IDENTITY NUMBER:

--	--	--	--	--	--	--	--	--	--	--	--	--	--	--	--	--	--	--	--

Day	Date	Time In	Signature	Time Out	Signature	Report On Any Formal Training Provided In The Reporting Month
WEEK 1						
MONDAY						
TUESDAY						
WEDNESDAY						
THURSDAY						
FRIDAY						
WEEK 2						
MONDAY						
TUESDAY						
WEDNESDAY						
THURSDAY						
FRIDAY						
WEEK 3						
MONDAY						
TUESDAY						
WEDNESDAY						
THURSDAY						
FRIDAY						
WEEK 4						
MONDAY						
TUESDAY						
WEDNESDAY						
THURSDAY						
FRIDAY						
WEEK 5						
MONDAY						
TUESDAY						
WEDNESDAY						
THURSDAY						
FRIDAY						
Total Days worked						

PART C4: SITE INFORMATION

<u>TABLE OF CONTENTS</u>	Page
C4.1 LOCALITY PLAN	C134
C4.2 EXAMPLE OF CONTRACT SIGNBOARD DETAILS	C135
C4.3 EXISTING SERVICES REPORT	C137
C4.4 CONDITIONS ON SITE: MATERIALS INFORMATION	C138

C4.1 LOCALITY PLAN

P494 CO-ORDINATES Lat: 28.54457° S
Lon: 31.94584° E



C4.2 EXAMPLE OF CONTRACT SIGNBOARD DETAILS

C4.2.1 CONTRACT SIGNBOARD FOR USE WHEN THE NYS PROGRAMME IS NOT REQUIRED:

Note: The “S’hamba Sonke” logo, as indicated below, shall appear on the signboard for Provincial Road Maintenance Grant (PRMG) contracts only. In all other cases it shall be omitted.

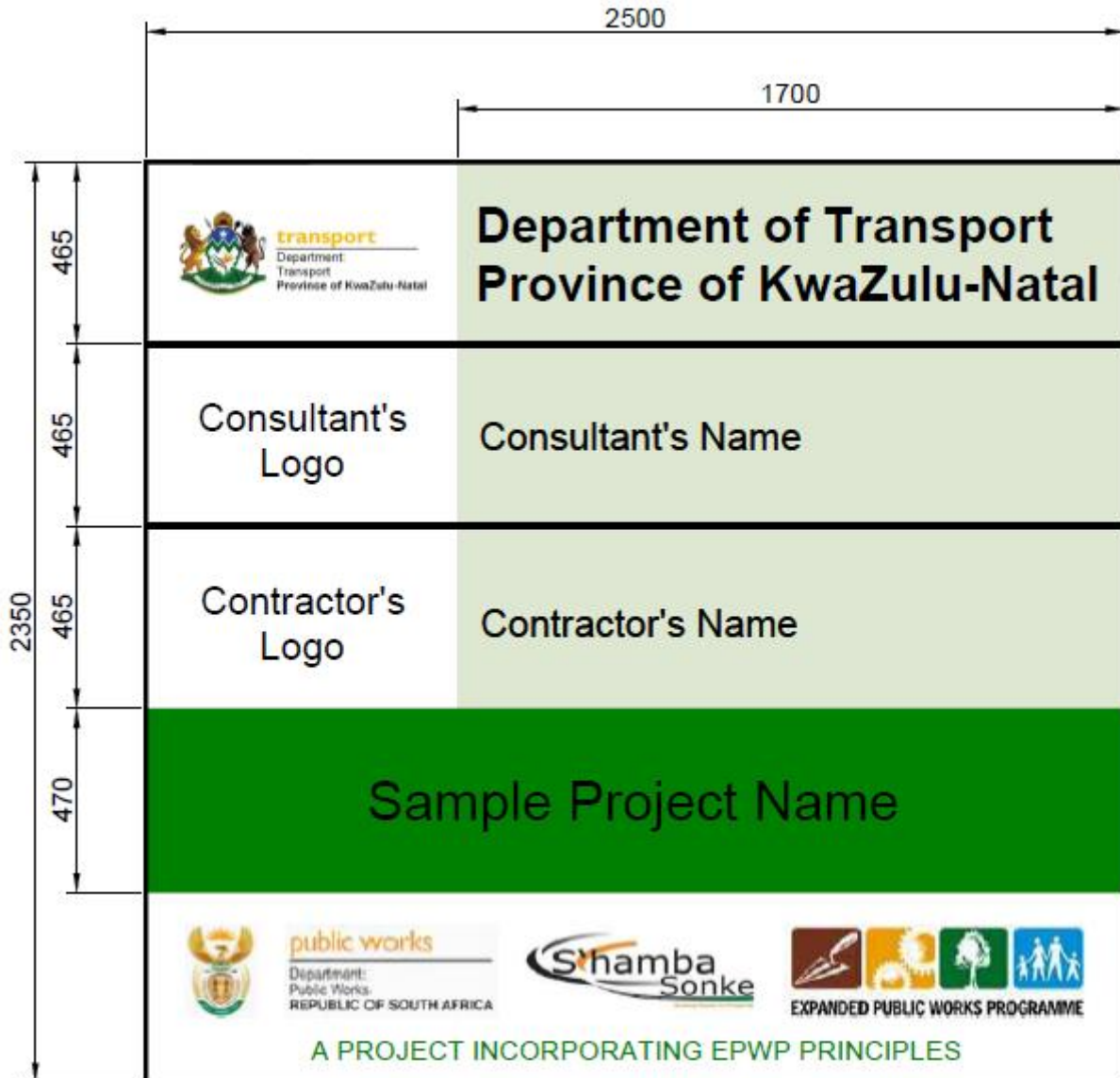

C4.2.2 CONTRACT SIGNBOARD FOR USE WHEN THE NYS PROGRAMME IS REQUIRED:

Note: The “S’hamba Sonke” logo, as indicated below, shall appear on the signboard for Provincial Road Maintenance Grant (PRMG) contracts only. In all other cases it shall be omitted.

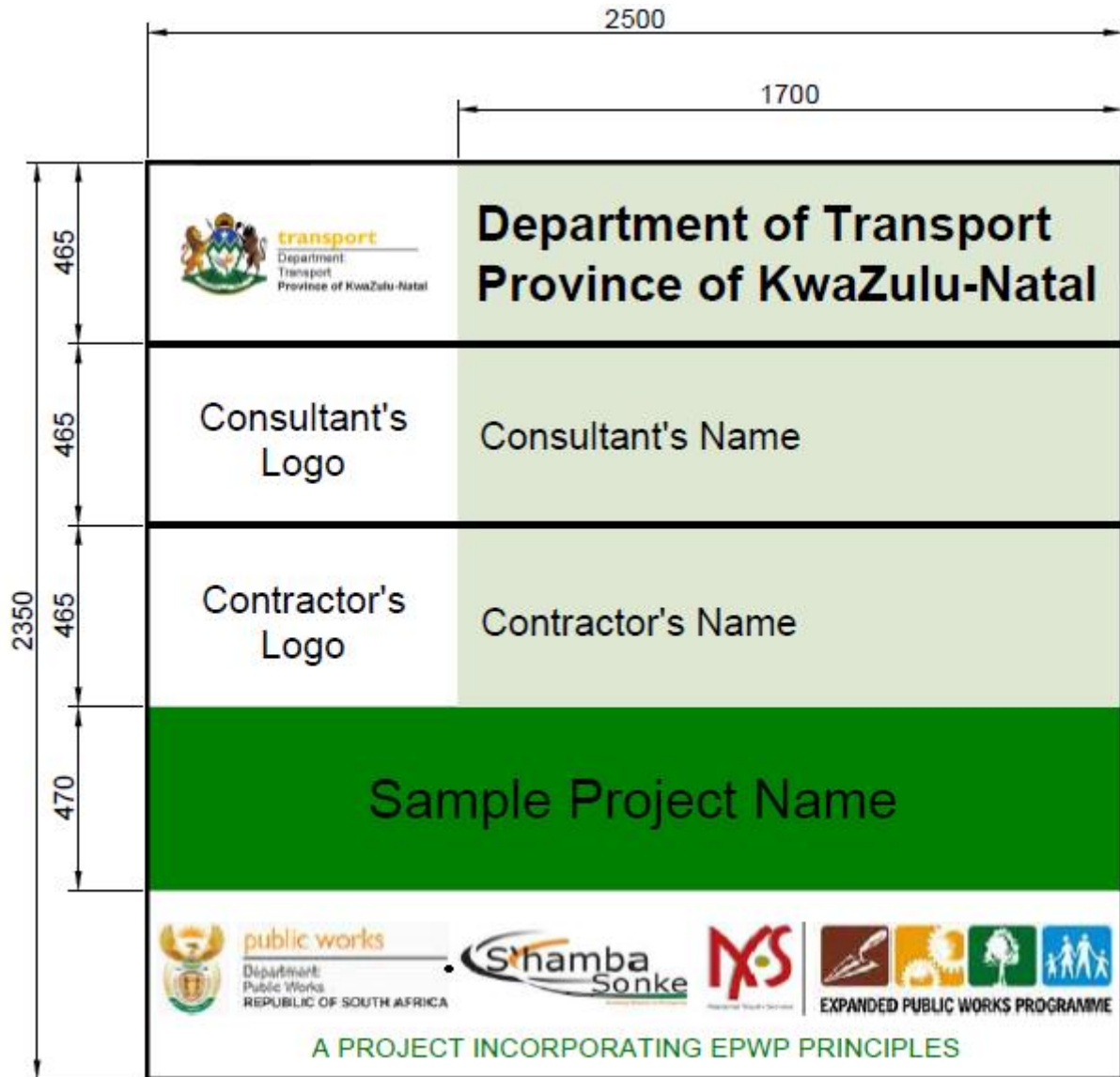

C4.3 EXISTING SERVICES REPORT

1. Location of services

The following services are scheduled for relocation under this contract:

It is also expected that unknown buried domestic services crossings requiring relocation or protection may be encountered along the route as the work proceeds. The Contractor shall therefore make every effort to establish the location of any such unknown services in a particular area prior to excavations commencing in that area. Such efforts shall include the Contractor conducting a thorough visual surface inspection for services in the area, and also diligently enquiring of local landowners as to whether there are any known services which have not been shown on the drawings but which may be affected by the construction activities in that area, and any such services shall be brought to the attention of the Employer's Agent immediately. Exploratory hand excavation trenching work shall be carried out where necessary to establish the exact position of buried services.

The Contractor shall take note of the requirements of clause 1202 of the standard specifications with regard to services.

2. Liaison with service owners

Immediately after the site has been handed over to the Contractor and prior to the commencement of any construction work on the site, the Contractor shall arrange a meeting with the relevant authorities to establish the exact location of the various services affected (if any), to plan the necessary services relocations (if required) and to obtain contact details for the service owners' technical and emergency staff.

Where services relocations are required, the Contractor shall arrange regular planning meetings with the service owners until such time as the services have been relocated and commissioned and the existing services uplifted and removed.

3. Protection of existing services

Prior to the commencement of any construction work on the site, the Contractor shall establish markers at 50 m centres (or closer where necessary), clearly delineating the routes traversed by the services within the road reserve as confirmed by the service owners.

Excavation operations shall commence only after the existing services within or in the near vicinity of the excavations have been suitably protected against damage.

The Contractor shall take particular care when carrying out blasting, pneumatic or mechanical breaking, and general excavation operations in the vicinity of the services, and subcontractors, foremen and plant operators shall be fully briefed on precautionary measures to be taken before excavation commences in these areas.

4. Relocation of services

Should any services need to be relocated, the Contractor shall be required to assist the service owner with programming, organising and carrying out the relocation work, in order to minimise any delays in the construction.

5. Payment for the services relocation work

A provisional sum has been provided under section 1200 of the bill of quantities to cover the costs of any protection, relocation, realignment, removal or replacement of services that may arise.

C4.4 CONDITIONS ON SITE: MATERIALS INFORMATION

CONTENTS	PAGE
C4.4.1 DISCLAIMER	C139
C4.4.2 GENERAL DESCRIPTION OF ROAD	C139
C4.4.3 BORROW PIT INVESTIGATION.....	C139
C4.4.4 MATERIALS FOR CONSTRUCTION	C139

C4.4.1 DISCLAIMER

The information in this document records the results of investigations done and various tests carried out on materials encountered in the existing road. The results are given in good faith and there is no warranty that the results are entirely representative of all the materials that may be encountered, the intention being to give an indication of the materials likely to be encountered.

No responsibility for any consequence arising from variation between the actual material properties and those indicated in this document will be accepted.

The specification and contract drawings shall always overrule this part of the contract documents.

C4.4.2 GENERAL DESCRIPTION OF ROAD

The existing road is gravel surfaced with a nominal width of 8 metres. The overall length is approximately 30 km of which 7,4 km is dealt with in this document.

P700 traverses the hilly to mountainous terrain of rural KwaZulu-Natal from Ulundi in a south-easterly direction towards Empangeni. It crosses the Coal Line at km 28,75, the White Mfolozi River at km 32,5 and the Munywana River at km 39,840. The route generally follows the alignment of the existing P700 except for a portion that will be realigned across scrub bush lands from the Munywana River at km 39,9 to km 41,8 to provide a more direct link from Ulundi to Empangeni.

This contract commences at km 32,620 at the south-eastern abutment of the recently constructed White Mfolozi River Bridge. Most of the earthworks have already been completed to formation level from km 32,620 to km 35,000 except for the deep cutting between km 33,600 and km 34,020.

From km 35,0 to km 36,0 the route is located at the top of the watershed from where it descends to the Munywana River at km 39,850. The average gradient between km 36,8 and km 38,1 is 7% with the steepest portion at 10% occurring between km 36,8 and km 37,3. The gradient flattens between km 38,1 and km 38,7 and then steepens to an average of 4,5% to the Munywana River. The end point of this contract is at km 40,0 where it will tie into an existing gravel road. The earthworks will however continue to km 40,100.

C4.4.3 BORROW PIT INVESTIGATION

Five test pits were excavated in the weathered granite borrow area at km 35,0 RHS. G5 material was found in the test pits at the crest of the ridge and G8 quality material 100m downhill of the ridge.

Five test pits were excavated in the weathered dolerite borrow area located 4 kilometres south-east of km 39,0. G6 material was found in 4 of the 5 test pits excavated to approximately 2m depth. The average thickness of overburden was 350mm.

Further testing will determine the optimum cementing agent and proportions to be mixed with the natural material to produce C3 quality subbase.

The borrow pit test results are given in Appendix B.

C4.4.4 MATERIAL FOR CONSTRUCTION

C4.4.4.1 Selected subgrade and subbase layers

Results of tests on material sampled from the cuttings for use in the construction of pavement layers are provided in Appendix A4.

Tests on tillite and sandstone materials excavated in the cuttings from km 32,760 to km 33,020 and from km 34,250 to km 34,550 have proved the material durable, in terms of the Venter test and 10% FACT test, for G9 lower selected subgrade, G7 upper selected subgrade and G6 natural subbase.

Stabilisation tests have been undertaken on tillite materials sampled from the cutting at km 32,880 and km 32,900. It was found that the use of cement rather than lime as the stabilising agent resulted in higher Unconfined Compressive Strengths and Indirect Tensile Strengths. Strengths required for C3 chemically stabilised subbase were achieved by the addition of 3% by mass of cement.

Stabilisation tests on material stockpiled at km 33,620 demonstrated that C3 strengths were achievable by the addition of 1% by mass of lime and 1% by mass of cement.

Material sampled from the cutting at km 34,360 achieved a CBR of 30% at 95% of modified AASHTO density but the CBR swell was in excess of 1% and the material was thus classified as G7. Stabilisation tests on the material demonstrated that the addition of a blend of lime and cement resulted in higher UCS and ITS strengths when compared to the strengths achieved by the addition of only cement or only lime.

It is expected that the following materials for pavement layers can be obtained from the cutting km 33,600 and km 34,020:

- 13 500 m³ intermediate material for LSSG.
- 12 800 m³ hard to intermediate material for USSG. The material may require single stage crushing and additional grid rolling.
- 11 850 m³ hard tillite proven suitable for subbase for crushing.

Alternative sources of layer work materials are the proposed borrow area on the right-hand side of the road near km 35,0 and the additional area located 4 kilometres south-east of km 39,0.

C4.4.4.2 Crushed stone base

The G2 required for the construction of the crushed stone base shall be obtained from commercial sources.

The nearest commercial sources are Lancaster Crushers near Ulundi and Lafarge at Empangeni (Bay Stone/Ninians).

Results of tests done by site laboratories on material supplied from these sources are supplied in Appendix A4.

Test results showed that the gradings of the G2 material from Lancaster Crushers and the G1 material from Lafarge were on the coarse side of the specified grading envelopes. Blending with fines is likely to be required to ensure the material conforms to the standard specifications.

C4.4.4.3 Concrete and surface seal aggregate, gabion stone and stone for erosion protection works

Crushed stone shall be obtained from commercial source. The nearest commercial sources are Lancaster Crushers near Ulundi and Lafarge at Empangeni (Bay Stone/Ninians).

Results of tests done by site laboratories on material supplied from these sources are supplied in Appendix A4.

Test results showed that the grading of the 20,0mm surfacing stone sampled from Lafarge is oversize with respect to the requirements of [Table 4302/8](#) of the Standard Specifications for Road and Bridge Works for South African Road Authorities (COTO), Draft Standard (DS), October 2020.

C4.4.4.4 Natural sand

No specific source of sand was identified. The Contractor will have to make his own arrangements for the procurement of suitable sand for concrete, drainage and other construction purposes from commercial sources.

C4.4.4.5 Water

No specific source of water for construction purposes is identified. The Contractor will have to make his own arrangements in this regard. Water may be available from local rivers and streams but the Contractor will have to make suitable arrangements for access as required as well as for the necessary testing to prove its suitability.

**ANNEXURE A: GUIDELINES FOR CONSTRUCTION
AND MAINTENANCE PROJECTS DURING COVID-19 LOCKDOWN**



transport

Department:

Transport

Province of KwaZulu-Natal

PROJECT SITE OCCUPATIONAL HEALTH AND SAFETY

GUIDELINES FOR CONSTRUCTION AND MAINTENANCE PROJECTS DURING COVID-19 LOCKDOWN

Revision 1/1 July 2020

Contents

1	INTRODUCTION	148
1.1	BACKGROUND	148
1.2	PURPOSE	149
1.3	OBJECTIVES.....	149
2	RISK ASSESSMENT	149
2.1	BACK TO BASICS	149
2.2	IMPLEMENTATION OF CONTROL MEASURES	150
3	SITE OPERATING PROCEDURES	151
3.1	SELF-ISOLATION.....	151
3.2	IF SOMEONE FALLS ILL.....	151
3.3	TRAVEL TO SITE	151
3.4	SITE ACCESS POINTS	152
3.5	HAND WASHING.....	152
3.6	TOILET FACILITIES	152
3.7	CANTEENS AND EATING ARRANGEMENTS	152
3.8	CHANGING FACILITIES, SHOWERS AND DRYING ROOMS	153
3.9	AVOIDING CLOSE WORKING	153
3.10	GENERAL PRINCIPLES.....	153
3.11	SITE MEETINGS	153
3.12	CLEANING	154
4	CONSTRUCTION PROTOCOLS.....	154
4.1	PHYSICAL DISTANCING AND HYGIENE PROTOCOL	155
4.2	SITE TRANSPORTATION PROTOCOL	158
4.3	CLEANING PROTOCOL.....	159
4.4	SCREENING AND MONITORING PROTOCOL	161
	ACRONYMS	162
	KEY TERMS & DEFINITIONS	162
	APPENDIX A: SAFE PRACTICES ON SITE	163
	APPENDIX B: SUSPECTED OR CONFIRMED CASE OF COVID-19.....	164
	APPENDIX C: COVID-19 DAILY SYMPTOM MONITORING TOOL.....	165
	APPENDIX D: COVID-19 BASELINE RISK ASSESSMENT	166

Content of Figures

<u>Figure 1: COVID-19 Alert Levels</u>	<u>C145</u>
<u>Figure 2: Risk exposures</u>	<u>C146</u>
<u>Figure 3: Infection control strategies</u>	<u>C147</u>
<u>Figure 4: Symptoms of COVID-19</u>	<u>C148</u>

1 INTRODUCTION

Coronavirus Disease 2019 (COVID-19) is a respiratory disease caused by the SARS-CoV-2 virus. In order to reduce the impact of COVID-19 on businesses, workers, customers and the public, the Kwazulu-Natal Department of Transport (KZNDOT), within the parameters of the COVID-19 regulatory framework, want to ensure that all those businesses, workers, customers and public it's interacting with are in compliance to the requirements as stipulated to ensure a safe work-environment for all.

On 23 April 2020, President Cyril Ramaphosa addressed the nation and announced that the country would resume economic activity in a phased approach from 1 May 2020. The lockdown levels depicted by Figure 1 below, will be lifted in phases, level 5 the highest and level 1 being the lowest as depicted below:



Figure 1: COVID-19 Alert Levels

1.1 BACKGROUND

Occupational Health and Safety are a fundamental segment of the construction industry. Safety must be embedded in all processes, implementing a top down approach, enabling the adoption of a safe and healthy working culture by all. Individual businesses or workplaces must have COVID-19 risk assessments and prevention and mitigation plans in place, and must conduct worker education on COVID-19 and protection measures:

- Identification and protection of vulnerable employees
- Safe transport of employees
- Screening of employees on entering the workplace
- Prevention of viral spread in the workplace
- Hand sanitisers and face masks
- Cleaning of surfaces and shared equipment
- Good ventilation
- Shift arrangements and canteen controls
- Managing sick employees

In addition to the above, monitoring systems must be in place to ensure compliance with safety protocols and to identify infections among employees.

1.2 PURPOSE

This document sets out the key principles and minimum requirements of the KZNDOT that define responsible, healthy and safe operations for road construction related operations working under COVID-19 Lockdown. The present state of the lockdown is geared toward the revival of economic activities and to allow employees involved in permitted services to resume work under certain conditions. This COVID-19 guidance has been developed on the basis of traditional infection prevention and occupational hygiene practices.

1.3 OBJECTIVES

The aims of this document are to:

- Keep workers and the wider public healthy and safe by preventing the spread of COVID-19.
- Apply relevant guidance from the Department of Health, Department of Employment and Labour and other Government Authorities to the construction environment.
- Encourage a safe and respectful work environment and good communication between all stakeholders.
- Sit alongside existing health and safety controls to ensure workers are safe on site.

Contractors and their employees should use this guidance to help identify risk levels on construction sites and to identify any appropriate control measures to be implemented. Additional guidance may be needed as the conditions of the COVID-19 outbreak change and as new information about the virus, its transmission and impact become available. It focuses on, as well as considerations for, the need for contractors to implement engineering, administrative and work practice controls and personal protective equipment (PPE).

2 RISK ASSESSMENT

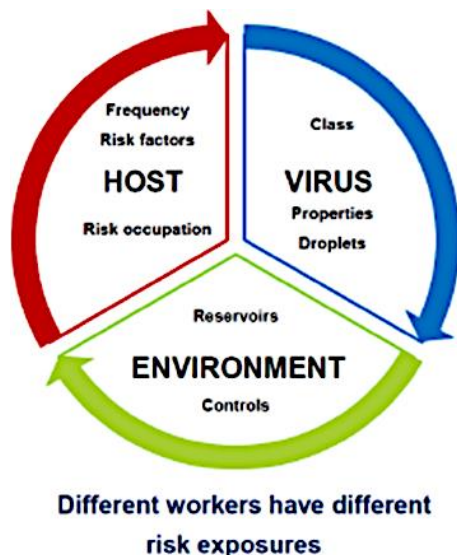

Figure 2: Risk Exposures

The legislation governing workplaces in relation to COVID –19 is the Occupational Health and Safety Act, Act 85 of 1993, as amended, and with the Hazardous Biological Agents Regulations and the Construction Regulation 2014. Section 8(1) of the Occupational Health and Safety Act, Act 85 of 1993, as amended, requires the employer to provide and maintain a working environment that is, to the extent possible reasonably practicable, as amended. Specifically, Section 8(2)(b) requires steps that may be reasonably practicable to eliminate or mitigate any hazard or potential hazard prior to the use of personal protective equipment (PPE).

2.1 BACK TO BASICS

Risk Assessment should be done to determine the **RISK** of **EXPOSURE** and to communicate this to the **WORKERS**.

2.2 IMPLEMENTATION OF CONTROL MEASURES

Before the implementation of control measures, current risk assessments need to be reviewed and updated, taking into account the new hazards posed by exposure to COVID-19 in the workplace. This is in accordance with Section 8 (2) (d) of the OHS Act.

With COVID-19, it may not be possible to eliminate the hazard, the most effective protection measures are engineering controls, administrative controls, safe work practices (a type of administrative control), and Personal Protection Equipment.

Measures for protecting workers from exposure to, and infection with, SARS-CoV-2, the virus that causes Coronavirus Disease 2019 (COVID-19), depend on the type of work being performed and exposure risk, including potential for interaction with people with suspected or confirmed COVID-19 and contamination of the work environment.

Contractors should adapt infection control strategies based on a thorough hazard assessment, using appropriate combinations of engineering and administrative controls, safe work practices, and personal protective equipment (PPE) to prevent worker exposures.

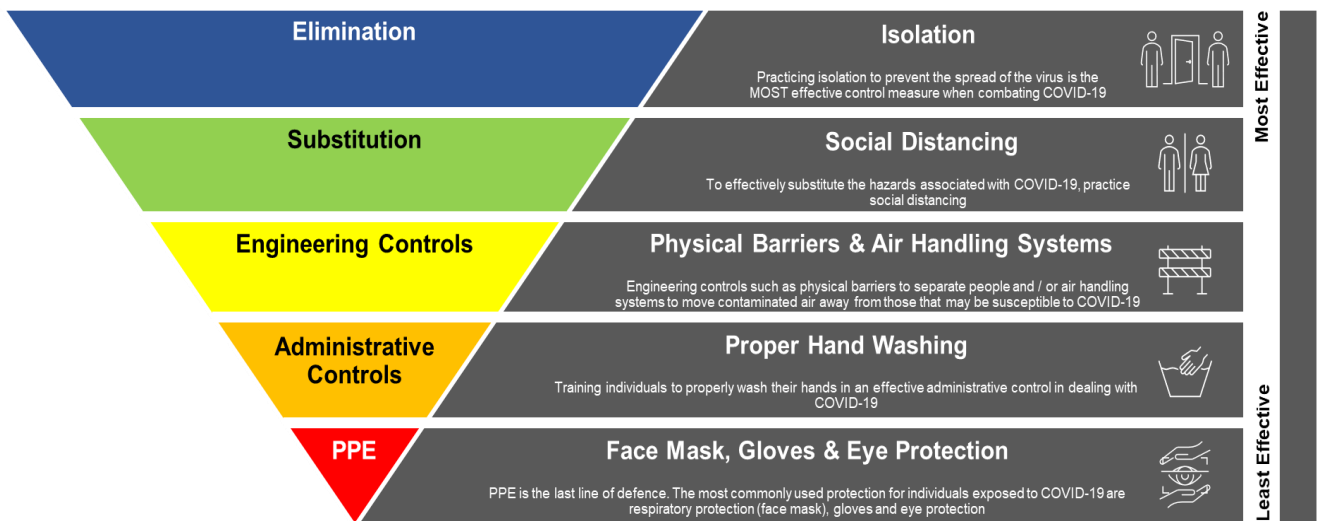

Figure 3: Infection Control Strategies

In preventing occupational exposure to COVID-19 also require Contractors to train workers on elements of infection prevention, including PPE. This would assist Contractors to identify:

- Exposure Levels
- “High Contact” Activities, and
- Vulnerable Workers and Special Measures

Contractors are expected to undertake and champion the principles of constantly focussing on eliminating or reducing the risk of COVID-19 transmission to an acceptable level, engaging meaningfully with their workforce, and making worker health a key priority. A Baseline Risk Assessment is included under Appendix D: COVID-19 Baseline Risk Assessment.

3 SITE OPERATING PROCEDURES

KZNDOT Construction sites operating during the Covid-19 pandemic need to ensure that they protect their workforce and minimise the risk of infection spread. In line with government guidelines on social distancing, this guideline is intended to implement effective steps at all KZNDOT construction sites of any size. These are extraordinary situations, and the KZNDOT intends to abide to the latest COVID-19 advice from national government.

3.1 SELF-ISOLATION

Anyone who meets one of the following criteria should not come to site:

- Has a high temperature or a new persistent cough;
- Is a vulnerable person (by virtue of their age, underlying health condition, clinical condition or pregnancy); or
- Is living with someone in self-isolation or with a vulnerable person.

3.2 IF SOMEONE FALLS ILL

If a worker develops a high temperature or a persistent cough while at work, they should:

- Return home immediately;
- Avoid touching anything; and
- Cough or sneeze into a tissue and put it in a bin, or if they do not have tissues, cough and sneeze into the crook or into the bent elbow.

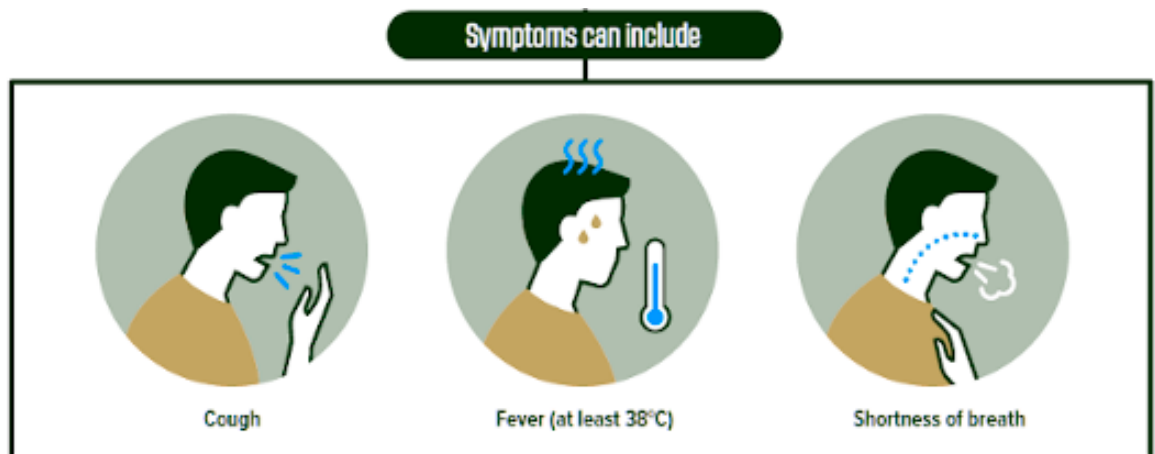

Figure 4: Symptoms of COVID-19

They must self-isolate and not return to work until their period of self-isolation has been completed and his or her negative status has been confirmed.

3.3 TRAVEL TO SITE

Wherever possible workers should travel to site alone using their own transport, and construction sites need to consider:

- Parking arrangements for additional cars, taxis, buses, etc;
- Other means of transport to avoid public transport e.g. cycling;
- They must ensure disinfecting the alternative transport before and after use; and Public Transport Regulations in respect of COVID-19 are adhered to;

- Providing hand cleaning facilities at entrances and exits. This should be soap, water and paper towels (and not fabric towels) wherever possible or hand sanitiser if water is not available; and
- How someone detected vulnerable after screening, taken ill and would get transported home.

3.4 SITE ACCESS POINTS

- Stop all non-essential visitors
- People, be it workers or visitors, without relevant face masks should not be allowed to enter construction sites; and workers should wear face masks at all times.
- Introduce staggered start and finish times to reduce congestion and contact at all times
- Monitor site access points to enable social distancing – you may need to change the number of access points, either increase to reduce congestion or decrease to enable monitoring
- Remove or disable entry systems that require skin contact e.g. fingerprint scanners
- Require all workers to wash or clean their hands before entering or leaving the site or as frequent as possible
- Allow plenty of space (two metres) between people waiting to enter site
- Regularly clean common contact surfaces in Site Office, Access Control and delivery areas e.g. scanners, turnstiles, screens, telephone handsets, desks, particularly during peak flow times
- Reduce the number of people in attendance at site inductions and consider holding them outdoors wherever possible
- Drivers should remain in their vehicles if the load will allow it and must wash or clean their hands before unloading goods and materials.

3.5 HAND WASHING

- Provide additional hand washing facilities to the usual welfare facilities on a large spread out site or significant numbers of personnel on site
- Ensure soap, fresh water and paper towels is always readily available and kept topped up
- Provide hand sanitiser where hand washing facilities are unavailable
- Regularly clean the hand washing facilities and check soap and sanitiser levels
- Provide suitable and enough rubbish bins for hand paper towels with regular removal and disposal.
- Sites will need extra supplies of soap, hand sanitiser and paper towels and these should be securely stored.

3.6 TOILET FACILITIES

- Restrict the number of people using toilet facilities at any one time e.g. use a welfare attendant
- Wash hands before and after using the facilities
- Enhance the cleaning regimes for toilet facilities particularly door handles, locks and the toilet flush handles or buttons
- Portable toilets should be avoided wherever possible, but where in use these should be cleaned and emptied more frequently
- Provide suitable and sufficient rubbish bins for hand towels with regular removal and disposal.

3.7 CANTEENS AND EATING ARRANGEMENTS

Whilst there is a requirement for construction sites to provide a means of heating food and making hot drinks, these are exceptional circumstances and where it is not possible to introduce a means of keeping equipment clean between use, kettles, microwaves etc. must be removed from use.

The workforce should also be required to stay on site once they have entered it and not use local shops.

- Dedicated eating areas should be identified on site to reduce food waste and contamination
- Break times should always be staggered to reduce congestion and contact
- Hand cleaning facilities or hand sanitiser should be available at the entrance of any room where people eat and should be used by workers when entering and leaving the area
- The workforce should be asked to bring pre-prepared meals and refillable drinking bottles from home
- Workers should sit 2 metres apart from each other whilst eating and avoid all contact
- Where catering is provided on site, it should provide pre-prepared and wrapped food only
- Crockery, eating utensils, cups etc. should not be used
- Drinking water should be provided with enhanced cleaning measures of the tap mechanism introduced
- Tables should be cleaned between each use
- All rubbish should be put straight in the bin and not left for someone else to clear up
- All areas used for eating must be thoroughly cleaned at the end of each break and shift, including chairs, door handles, vending machines and payment devices.

3.8 CHANGING FACILITIES, SHOWERS AND DRYING ROOMS

- Always introduce staggered start and finish times to reduce congestion and contact
- Introduce enhanced cleaning of all facilities throughout the day and at the end of each day
- Consider increasing the number or size of facilities available on site if possible
- Based on the size of each facility, determine how many people can use it at any one time to maintain a distance of 1 ½ metres
- Provide suitable and enough rubbish bins in these areas with regular removal and disposal.

3.9 AVOIDING CLOSE WORKING

There will be situations where it is not possible or safe for workers to distance themselves from each other by 1.5 metres.

3.10 GENERAL PRINCIPLES

- Non-essential physical work that requires close contact between workers should not be carried out
- Work requiring skin to skin contact should not be carried out
- Plan all other work to minimise contact between workers
- Re-usable PPE should be thoroughly cleaned after use and not shared between workers
- Single use PPE should be disposed of so that it cannot be reused
- Stairs should be used in preference to lifts or hoists
- Where lifts or hoists must be used:
 - Always lower their capacity to reduce congestion and contact
 - Regularly clean touchpoints, doors, buttons etc.
- Increase ventilation in enclosed spaces
- Regularly clean the inside of vehicle cabs and between use by different operators.

3.11 SITE MEETINGS

- Only absolutely necessary meeting participants should attend
- Attendees should be two metres apart from each other
- Rooms should be well ventilated / windows opened to allow fresh air circulation
- Consider holding meetings in open areas where possible.

3.12 SITE MEETINGS

Enhanced cleaning procedures should be in place across the site, particularly in communal areas and at touch points including:

- Taps and washing facilities
- Toilet flush and seats
- Door handles and push plates
- Handrails on staircases and corridors
- Lift and hoist controls
- Machinery and equipment controls
- Food preparation and eating surfaces
- Telephone equipment
- Keyboards, photocopiers and other office equipment

Rubbish collection and storage points should be increased and emptied regularly throughout and at the end of each day.

4 CONSTRUCTION PROTOCOLS

The core principle behind this “Construction Protocols” is to protect the health and safety of all workers required to perform duties during the COVID-19 crisis, including related health and safety impacts on operations related to operating under a COVID-19 environment, as well as protecting the wider KwaZulu-Natal population from transmission and spread of the virus.



Before
arriving on
Site

- Each Contractor must have a plan detailing the steps they will take to mitigate risks, including those presented by COVID-19. The details of the plan must be communicated to workers before they start work.
- Before any activity is recommenced the Contractor must ensure that all hazards have been reviewed and appropriately controlled before work activity is commenced after lockdown.
- Where possible, conduct a remote induction before arrival on site, this can be done via video conferencing or by phone.
- If an in-person induction is required, the **Physical Distancing and Hygiene Protocol** must be followed.
- All workers shall undergo a screening process to ensure they are fit for duty by confirming their health status.
- Contractors must understand how workers will travel to and from site and will communicate the **Site Transportation Protocol** to all.
- Ensure all workers understand when additional PPE may be required due to COVID-19 and that workers have access to the correct PPE as per the Department of Employment and Labour guidelines. When required to use face masks or gloves please follow these processes.

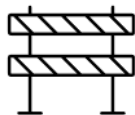

Site Entry

- Only relevant personnel to the workplace are to access the site.
- All office employees supporting a project will work remotely, where possible.
- A daily register of workers entering and leaving site must be completed along with a health declaration. Use your existing sign in register or the example Sign-in register.
- Signage reminding workers of the COVID-19 **Physical Distancing and Hygiene Protocol** will be posted at the site entrance and in common areas where appropriate.



Site
Operations

- All work is to be undertaken in such a way as to reduce any possible contact between workers and to promote physical distancing wherever possible, as per the **Physical Distancing and Hygiene Protocol**.
- All visitors to the site, such as necessary delivery workers, will be restricted to one person wherever possible. These workers must follow the **Site Transportation Protocol**.
- All offices and jobsites must implement cleaning measures as per the **Cleaning Protocol**.
- All tools, equipment, plant and vehicles must be used in alignment with the **Cleaning Protocol**.
- Toolbox talks should be held with physical distancing in place as per the **Physical Distancing and Hygiene Protocol**.
- Additional sanitary measures are to be implemented on site to prevent the spread of COVID-19 e.g. hand washing stations, provision of additional hand sanitizer, provision of disinfectant wiping products, as per the **Physical Distancing and Hygiene Protocol**.
- Smokers must follow the **Physical Distancing and Hygiene Protocol**.
- A COVID-19 Response plan must be available and accessible on site.



Leaving Site

- Workers must use the sign-in register to sign out.
- When returning home, workers will need to follow the necessary hygiene measures.
- Each site must be cleaned and sanitised at the end of the working day or end of each shift, as per the **Cleaning Protocol**.
- All waste and disposable PPE must be removed from site and securely disposed of as per the **Cleaning Protocol**.
- Workers must follow the **Site Transportation Protocol**.

4.1 PHYSICAL DISTANCING AND HYGIENE PROTOCOL

Physical distancing, also known as “social distancing”, is about keeping a safe distance from others. For physical distancing, at least one and ½ metre’s separation is required at work, and two metres in uncontrolled environments, like in public. This aligns with World Health Organisation advice. We expect one and ½ metre’s separation between people at work as the minimum and greater separation where it is reasonably practicable to do so. This is important to help protect us from COVID-19, which spreads via droplets from coughing and sneezing.

General
Working
Arrangements

- Keep team sizes as small as possible.
- Keep a record of who is in each team every day as it is required to assist contact tracing.
- Site teams are encouraged to put forward split/alternating shifts to avoid extensive intermingling to reduce potential of exposure.
- Work site is always to be segregated into zones (or by other methods) as much as possible to keep different teams/trades physically separated.
- Where possible, a one-way system in high-traffic areas, such as lifts, stairwells and scaffolds (Where Applicable).
- Where practical, all office employees supporting a project, work remotely.
- When using a vehicle, the **Cleaning Protocol** needs to be followed.
- When using a vehicle, limit this to one/two person per vehicle if possible.













External Interfaces	<ul style="list-style-type: none">• One member of the crew nominated to receive supplies etc.• Keep the engagement with the other person as brief as possible and maintain a two-metre physical distance.• Ask for paperwork to be emailed rather than handed over as much as possible.• If unavoidable, then either wear gloves when handling the item or wash hands before and after handling said items.
Site Entry	<ul style="list-style-type: none">• Limit visitors to site wherever possible.• Introduce staggered start and finish times where possible to reduce congestion and contact.• Monitor site access points to enable physical distancing – you may need to change the number of access points, increase to reduce congestion or decrease to enable monitoring.• Where entry systems that require skin contact, the Cleaning Guide must be followed.• Require all workers to wash or clean their hands before entering and leaving the site.• Allow plenty of space 1½ metres between people waiting to enter site.• Regularly clean common contact surfaces in reception, office, access control and delivery areas e.g. scanners, turnstiles, screens, telephone handsets, desks, particularly during peak flow times.• Where possible, conduct a remote induction before arrival on site, this can be done via video conferencing or by phone. If an in-person induction is required, reduce the number of people and hold them outdoors wherever possible.• Delivery drivers should remain in their vehicles if the load will allow it and must wash or clean their hands before unloading goods and materials.• Any sign in registers should be recorded by one person where possible – do not pass material around the group and minimise contact with any screens.
Site Meetings	<ul style="list-style-type: none">• Only absolutely necessary meeting participants should attend.• Attendees should be two metres apart from each other• Rooms should be well ventilated / windows opened to allow fresh air circulation.• Hold meetings in open areas where possible.• Meetings are to be held through teleconferencing or videoconferencing where possible.
Avoiding Close Working	<ul style="list-style-type: none">• Risk assessments and method statements must be updated to include COVID-19 control measures.• At least 1½ metre's separation is required at work. KZNDOT expect 1½ metre separation between people at work as the minimum and greater separation where it is reasonably practicable to do so.• If it is not possible or safe for workers to distance themselves by one metre for a work activity, the works should not be carried out.• Re-usable PPE should be thoroughly cleaned after use and not shared between workers.• Single use PPE should be disposed of so that it cannot be reused.• Stairs should be used in preference to lifts or hoists.• Where lifts or hoists must be used:<ul style="list-style-type: none">• Lower their capacity to reduce congestion.• Regularly clean touchpoints, doors, buttons etc.• Increase ventilation in enclosed spaces

Toilet Facilities	<ul style="list-style-type: none"> Physical distancing rules apply to the use of shared facilities, including toilets. Wash hands before and after using the facilities. Enhance the cleaning regimes for toilet facilities particularly door handles, locks, toilet flush and sanitary bins. Provide suitable and sufficient rubbish bins for hand towels with regular removal and disposal.
Eating Measures	<ul style="list-style-type: none"> If you need to leave site for any reason, follow site entry procedures on return. Dedicated eating areas should be identified on site to reduce food waste and contamination. Break times should be staggered to reduce congestion and contact at all times. Hand cleaning facilities or hand sanitiser should be available at the entrance of any room where people eat and should be used by workers when entering and leaving the area. The workforce should be asked to bring pre-prepared meals and refillable drinking bottles from home. Workers should sit 2 metres apart from each other whilst eating and avoid all contact. Where catering is provided on site, it should provide pre-prepared and wrapped food only. Shared crockery, eating utensils, cups etc. should not be used. Tables should be cleaned between each use. All rubbish should be put straight in the bin and not left for someone else to clear up. All areas used for eating must be thoroughly cleaned at the end of each break and shift, including chairs, door handles. Limit access and use of water fountains. Consider numbers on site for site facilities as physical distancing may require additional space/facilities.
Changing Facilities, Showers and Drying Rooms	<ul style="list-style-type: none"> Introduce staggered start and finish times to reduce congestion and contact at all times. Introduce enhanced cleaning of all facilities throughout the day and at the end of each day. Consider increasing the number or size of facilities available on site if possible. Based on the size of each facility, determine how many people can use it at any one time to maintain a distance of one metre. Provide suitable and sufficient rubbish bins in these areas with regular removal and disposal.
General Hygiene	<ul style="list-style-type: none"> Each worker must sanitise their hands with hand sanitiser or soap and running water before entry onto site, use warm water if available. Set up a specific place near the entry of the site for handwashing and/ or sanitising. Any personal items brought to site by workers must be segregated (kept separate from other workers items). Individual PPE for workers must be kept separate from other workers PPE and cleaned correctly as per the Cleaning Protocol. All eating and drinking utensils to be cleaned by the user. Have paper towels accessible to dry.
Smoking	<ul style="list-style-type: none"> Smokers/vapers must use designated area or do so off-site and butts are to be placed in the designated receptacle. Hands must be washed before and after smoking. Stand so that smoke or vapor produced is not going into another person's breathing zone.

-
- | | |
|--------------|--|
| Hand Washing | <ul style="list-style-type: none"> • Provide additional hand washing facilities to the usual welfare facilities on large, spread out sites or significant numbers of personnel on site. • Ensure soap and fresh water is readily available and kept topped up at all times. • Provide hand sanitiser where hand washing facilities are unavailable. • Regularly clean the hand washing facilities and check soap and sanitiser levels. • Sites will need extra supplies of soap, hand sanitiser and paper towels and these should be securely stored. |
|--------------|--|
-

4.2 SITE TRANSPORTATION PROTOCOL

Employers are required to have an understanding of how workers will travel to and from site.

-
- | | |
|------------------------|---|
| Workers travel to site |  Workers are to travel to the site one person per vehicle where possible. |
| |  Log is to be kept recording who has arrived on site, how they travelled and who they travelled with for contact tracing purposes. |
| |  Workers must travel home in the same vehicle as they arrived in. |
| |  Handwashing protocols to be observed before entering site. |
-
- | | |
|---|---|
| Any travel managed by the employer should ensure that adequate steps can be achieved for this transport which includes: |  Allowing for spaces between passengers. |
| |  Hygienic washing of hands before and after the journey. |
| |  Follow Vehicle Cleaning Procedures as per the Cleaning Protocols. |
| |  Restricting equipment and baggage to trailers and or separate parts of the vehicle. |
-
- | | |
|--------------------|---|
| Deliveries to site |  Deliveries to site should be delivered by one person only where possible. |
| |  Handwashing protocols to be observed once arrived at site. |
| |  Sign-in register must be completed for persons delivering goods to site. |
| |  1,5 m physical distancing rules to be applied at all times. |
-

4.3 CLEANING PROTOCOL

Construction Sites operating under Coronavirus COVID-19 Lockdown need to ensure they are protecting their workforce and minimising the risk of spread of infection.

Key Cleaning Tips

All construction sites (offices and jobsites included) should implement additional cleaning measures of common areas to help minimise the spread of COVID-19. Consider your work environment and what is frequently used and touched by workers, customers and others. The virus can be spread from person to person or by touching unclean equipment or surfaces. To stop the spread, focus efforts on cleaning areas where the virus is more likely to spread, such as the kitchen and toilet.

- Schedule regular cleaning.
- Use a suitable cleaning product.
- Use disposable cloths, if available.
- Always wear disposable gloves when cleaning. When finished, place used gloves in a rubbish bin.
- Wear disposable gloves while handling soiled items.
- Wash hands immediately after removing gloves or after handling these items.

Physical distancing should also be practiced when cleaning offices and jobsites. Refer to the **Physical Distancing and Hygiene Protocol** for more information.

Disinfecting Cleaning Aids

Cleaning aids, such as cloths or mops, must be germ-free or they'll spread germs to other surfaces. To help prevent the spread of germs:

- Use disposable cloths or paper towels when possible.
- Reusable cloths should be disinfected or washed after each use.
- Wash brushes in a dishwasher regularly or clean with detergent and warm water after each use.
- Use two buckets for mopping - one for detergent and the other for rinsing.
- Mops and buckets should be cleaned and dried after each use.

Site Cleaning

Before leaving the jobsite at the end of the working day or end of each shift, wipe down any tables/surfaces with soapy water or cleaning agents where possible. All workers must be checked out of site and record kept daily.

Common touch points may include:

- All waste and disposable PPE must be securely disposed of.
- All door handles, railings and personal workstation areas are wiped down with a disinfectant, such as disinfectant wipes. Individuals are responsible for cleaning their workstation area with disinfectant wipes.
- Clean all 'high-touch' surfaces such as desks, counters, tabletops, doorknobs, bathroom fixtures, toilets, light switches, phones, and keyboards every day with antiseptic wipes or disinfectant, including bleach solutions.

Cleaning Bathrooms, Toilets and Showers	<p>Clean toilets with a separate set of cleaning equipment (disposable cleaning cloths, mops, etc).</p> <p>Clean sinks frequently if they're used regularly. If your jobsite has a shower:</p> <ul style="list-style-type: none">• Clean shower trays frequently, if used regularly.• If a shower has not been used for a while, let it run with hot water before using it.• Keep tiles and grout in good condition.• Clean shower curtains frequently. Common toilet touch points may include:• Keep the U-bend and toilet bowl clean by flushing after each use.• Limescale should be regularly removed using a descaling product.• Keep the toilet seat, handle and rim clean by using a disinfectant.
Cleaning Tools and Equipment	<ul style="list-style-type: none">• Clean tools and equipment before and after each day's work with a disinfectant, concentrating on points of contact such as handles.• Wash your hands after handling tools and equipment to prevent the spread of germs.• If possible, don't share tools on-site. If sharing cannot be prevented, take precautions and follow the hand washing guide before and after each use.
Cleaning Vehicles	<ul style="list-style-type: none">• Have dedicated drivers when using vehicles to avoid the spread of germs.• Don't share vehicles if possible, if you need to use a shared vehicle then wipe down the common touched areas of the vehicle after each use (steering wheel, handbrake, gear stick, dashboard, handles, etc) and wash hands before and after using the vehicle.• Wipe down the inside and common touched areas of the vehicle before and after each day.• Have one person per vehicle where possible. If you are required to have more than one person then keep as much distance between people as possible, open the windows to keep air circulating and passengers to face towards the window to reduce the spread of germs.• If you need to have multiple people in a vehicle, then where possible, split teams into groups and stay in those groups when you travel together.
Cleaning PPE	<ul style="list-style-type: none">• Work clothes to be placed in washing machines and clean reusable PPE.• Read and follow directions on the labels of laundry or clothing and detergent. In general, wash and dry laundry and clothing with the warmest temperatures recommended on the label.• When handling soiled laundry wash your hands afterwards. All clothes and towels should be washed with a laundry product to prevent germs from spreading.• Don't leave laundry in the washing machine – any remaining germs can multiply rapidly.
Specialist Clean	<ul style="list-style-type: none">• If a worker is unwell and removed from site, a specialist clean will be completed in the area/ areas identified where the worker was working and has accessed. These areas are to be isolated until a specialist clean has taken place.• All equipment and vehicles used must be cleaned down and disinfected, concentrating on points of contact such as handles, steering wheels etc.

4.4 SCREENING AND MONITORING PROTOCOL

Construction Sites operating under Coronavirus COVID-19 Lockdown need to ensure they are protecting their workforce and minimising the risk of spread of infection. Screening is a method to assess the possibility of employees and visitors who may have symptoms or have been infected with COVID-19. Rigid screening of employees must take place every day before they enter the workplace. This will be the most effective way to control the spread of the virus within the workplace.

Employees should be screened for COVID-19 related symptoms and report such symptoms to a designated person and / or occupational health practitioner prior to entry into the workplace or work area in order for a decision to be made as to the staff member's continued attendance at work.

During Screening	<ul style="list-style-type: none">• At the start of a workday/shift and prior to ending the workday/shift, designated persons and / or occupational health practitioner must check with employees whether they have experienced sudden onset of any of the following symptoms: cough, shortness of breath or fever/chills (or $\geq 38^{\circ}\text{C}$ measured temperature if this is available at the worksite), in the past 24 hours as outlined in Daily Symptom Monitoring Tool.• If an employee reports any of the above-mentioned symptoms, they should immediately be provided with a FFP1 surgical mask and referred to the designated staff at the workplace so that arrangements can be made for COVID-19 testing at the closest testing centre.• If employee report any additional symptoms as outlined in the symptom monitoring sheet, s/he should be provided with a surgical mask and referred to the occupational health clinic, family practitioner or primary care clinic for further clinical evaluation and requirement for COVID-19 testing if indicated.• On receiving their results, the employee and/or health professional supporting the employee should notify their workplace so that the employee is managed accordingly. The workplace should proactively take steps to obtain this information to avoid any delays in reporting.
After isolation or quarantine period	<ul style="list-style-type: none">• Undergo medical evaluation to confirm that they are fit to work• Wearing of surgical masks at all times while at work for a period of 21 days from the initial test• Implement social distancing measures as appropriate (in the case of health workers avoiding contact with severely immunocompromised patients)• Adherence to hand hygiene, respiratory hygiene, and cough etiquette• Continued self-monitoring for symptoms, and seek medical re-evaluation if respiratory symptoms recur or worsen

“Appendix C: COVID-19 Daily Symptom Monitoring Tool” is a monitoring Tool to track construction workers on a daily basis for two weeks.

ACRONYMS

PPE	Personal Protective Equipment
WHO	World Health Organization
NICD	National Institute of Communicable Diseases
RR	Residual Risk
OHS Act	Occupational Health and Safety Act, 1993 (Act No. 85 of 1993)

KEY TERMS & DEFINITIONS

Contractor	Is defined as a person or company that arranges to supply materials or workers for building or for moving goods.
Extremely Vulnerable Persons	Defined as someone who is solid organ transplant recipients; people with specific cancers: people with cancer who are undergoing active chemotherapy or radical radiotherapy for lung cancer; people with cancers of the blood or bone marrow such as leukaemia, lymphoma or myeloma who are at any stage of treatment; people having immunotherapy or other continuing antibody treatments for cancer; people having other targeted cancer treatments which can affect the immune system, such as protein kinase inhibitors or PARP inhibitors; people who have had bone marrow or stem cell transplants in the last 6 months, or who are still taking immunosuppressive drugs; People with severe respiratory conditions including all cystic fibrosis, severe asthma and severe COPD; People with rare diseases and inborn errors of metabolism that significantly increase the risk of infections (such as SCID, homozygous sickle cell); People on immunosuppression therapies sufficient to significantly increase risk of infection; Women who are pregnant with significant heart disease, congenital or acquired.)
Physical Distancing	Physical distancing, also known as “social distancing”, is about keeping a safe distance from others.
Safe Work Practices	Safe work practices are types of administrative controls that include procedures for safe and proper work used to reduce the duration, frequency, or intensity of exposure to a hazard.
Screening	Screening is a way for health workers to find out if you may have COVID-19 or not. The health worker will ask you questions and scan your forehead to take your temperature.
Workplace	Workplace means any premises or place where a person performs work.

APPENDIX A: SAFE PRACTICES ON SITE

Using Face Masks on Site



Wash Hands First

Always make sure you wash your hands thoroughly before and after touching a mask.



Masks

There are many kinds of masks, depending on the task.



The Right Side

There is a metal clip at the top of the mask.



Placement

Place the metal clip across the top of your nose.



Attach the Mask

Attach the mask by pulling the elastic bands over your ears.



Stretch Down

Stretch the mask down, so that it covers your chin.



Adjust

Bend the metal clip around your nose so that it sits securely.



Taking off the Mask

Pull the elastic bands away from your ears.



Disposal

Always place the used mask in a closed rubbish bin for secure disposal.

Using Face Masks on Site



Any time you are completing a manual task

Use your usual work safety gloves



If you are cleaning any surfaces

Use disposable gloves for this and throw them in the bin when you finish cleaning



Avoid touching your face while wearing gloves



Remove your gloves and then wash your hands prior to eating, drinking or smoking/vaping



Practice good hand hygiene and good cough and sneeze etiquette while wearing gloves

APPENDIX B: SUSPECTED OR CONFIRMED CASE OF COVID-19

If the suspected or confirmed case of COVID-19 is at work



Isolate

Isolate the person from others and provide a disposable surgical mask, if available, for the person to wear.



Inform

Call (Insert No). Follow the advice of health officials.



Transport

Ensure the person has transport to their home or to a medical facility



Clean

Clean the area where the person was working and all places they have been. This may mean evacuating those areas. Use PPE when cleaning. Identify who at the workplace had close contact with the infected person in the 24 hours before that infected person started showing symptoms. Send those people home to isolate. Allow employees to raise concerns.



Identify



Clean

Clean the area where the person was working and all places they have been. This may mean evacuating those areas. Use PPE when cleaning. Review risk management controls relating to COVID-19 and review whether work may need to change. Keep employees up to date on what is happening.



Review

If the suspected or confirmed case of COVID-19 is not at work when diagnosed



Inform

Call (Insert No). Follow the advice of health officials.



Identify

Identify who at the workplace had close contact with the infected person in the 24 hours before that infected person started showing symptoms. Send those people home to isolate. Allow employees to raise concerns. Clean the area where the person was working and all places they have been. This may mean evacuating those areas. Use PPE when cleaning.



Clean



Review

Review risk management controls relating to COVID-19 and review whether work may need to change. Keep employees up to date on what is happening.

APPENDIX C: COVID-19 DAILY SYMPTOM MONITORING TOOL



COVID-19 DAILY SYMPTOM MONITORING TOOL

Details of Worker				Details of Person completing this form		Date completing form	
Identifier	Date of contact	DD/MM/YYYY	Place last contact	Surname	Name	DD/MM/YYYY	
Surname	Name			Role	Facility name		
Date of birth	DD/MM/YYYY	Age (Y)	Sex M <input type="checkbox"/> F <input type="checkbox"/>	Email address	Telephone number		
Healthcare worker	Y <input type="checkbox"/> N <input type="checkbox"/> If yes, facility name			Next of kin details			
Contact number(s)	Email			Next of Kin name and surname	Next of Kin contact number		
Physical address							
House number	Street			Suburb	Town		
District	Province			Patient traced	Y <input type="checkbox"/> N <input type="checkbox"/>		
Details of confirmed COVID-19 case (Complete only if Applicable)							
Contact type ¹	Close <input type="checkbox"/> Casual <input type="checkbox"/>	Relationship		Name	Surname	Date of Birth DD/MM/YYYY	

Instructions for completion: Mark "Y" if symptom present and "N" if not. If any symptoms are present collect, contact (Insert No) immediately and make immediate arrangements for the collection of a combined nasopharyngeal and oropharyngeal swab. Refer to COVID-19 Quick Guide on the NICD website for additional details. Days post exposure to case.

DAY	1	2	3	4	5	6	7	8	9	10	11	12	13	14
Date (DD/MM)														
Measured body temp														
Chills	<input type="checkbox"/> Y <input type="checkbox"/> N	<input type="checkbox"/> Y <input type="checkbox"/> N	<input type="checkbox"/> Y <input type="checkbox"/> N	<input type="checkbox"/> Y <input type="checkbox"/> N	<input type="checkbox"/> Y <input type="checkbox"/> N	<input type="checkbox"/> Y <input type="checkbox"/> N	<input type="checkbox"/> Y <input type="checkbox"/> N	<input type="checkbox"/> Y <input type="checkbox"/> N	<input type="checkbox"/> Y <input type="checkbox"/> N	<input type="checkbox"/> Y <input type="checkbox"/> N	<input type="checkbox"/> Y <input type="checkbox"/> N	<input type="checkbox"/> Y <input type="checkbox"/> N	<input type="checkbox"/> Y <input type="checkbox"/> N	<input type="checkbox"/> Y <input type="checkbox"/> N
Cough	<input type="checkbox"/> Y <input type="checkbox"/> N	<input type="checkbox"/> Y <input type="checkbox"/> N	<input type="checkbox"/> Y <input type="checkbox"/> N	<input type="checkbox"/> Y <input type="checkbox"/> N	<input type="checkbox"/> Y <input type="checkbox"/> N	<input type="checkbox"/> Y <input type="checkbox"/> N	<input type="checkbox"/> Y <input type="checkbox"/> N	<input type="checkbox"/> Y <input type="checkbox"/> N	<input type="checkbox"/> Y <input type="checkbox"/> N	<input type="checkbox"/> Y <input type="checkbox"/> N	<input type="checkbox"/> Y <input type="checkbox"/> N	<input type="checkbox"/> Y <input type="checkbox"/> N	<input type="checkbox"/> Y <input type="checkbox"/> N	<input type="checkbox"/> Y <input type="checkbox"/> N
Sore throat	<input type="checkbox"/> Y <input type="checkbox"/> N	<input type="checkbox"/> Y <input type="checkbox"/> N	<input type="checkbox"/> Y <input type="checkbox"/> N	<input type="checkbox"/> Y <input type="checkbox"/> N	<input type="checkbox"/> Y <input type="checkbox"/> N	<input type="checkbox"/> Y <input type="checkbox"/> N	<input type="checkbox"/> Y <input type="checkbox"/> N	<input type="checkbox"/> Y <input type="checkbox"/> N	<input type="checkbox"/> Y <input type="checkbox"/> N	<input type="checkbox"/> Y <input type="checkbox"/> N	<input type="checkbox"/> Y <input type="checkbox"/> N	<input type="checkbox"/> Y <input type="checkbox"/> N	<input type="checkbox"/> Y <input type="checkbox"/> N	<input type="checkbox"/> Y <input type="checkbox"/> N
Shortness of breath	<input type="checkbox"/> Y <input type="checkbox"/> N	<input type="checkbox"/> Y <input type="checkbox"/> N	<input type="checkbox"/> Y <input type="checkbox"/> N	<input type="checkbox"/> Y <input type="checkbox"/> N	<input type="checkbox"/> Y <input type="checkbox"/> N	<input type="checkbox"/> Y <input type="checkbox"/> N	<input type="checkbox"/> Y <input type="checkbox"/> N	<input type="checkbox"/> Y <input type="checkbox"/> N	<input type="checkbox"/> Y <input type="checkbox"/> N	<input type="checkbox"/> Y <input type="checkbox"/> N	<input type="checkbox"/> Y <input type="checkbox"/> N	<input type="checkbox"/> Y <input type="checkbox"/> N	<input type="checkbox"/> Y <input type="checkbox"/> N	<input type="checkbox"/> Y <input type="checkbox"/> N
Myalgia/body pains	<input type="checkbox"/> Y <input type="checkbox"/> N	<input type="checkbox"/> Y <input type="checkbox"/> N	<input type="checkbox"/> Y <input type="checkbox"/> N	<input type="checkbox"/> Y <input type="checkbox"/> N	<input type="checkbox"/> Y <input type="checkbox"/> N	<input type="checkbox"/> Y <input type="checkbox"/> N	<input type="checkbox"/> Y <input type="checkbox"/> N	<input type="checkbox"/> Y <input type="checkbox"/> N	<input type="checkbox"/> Y <input type="checkbox"/> N	<input type="checkbox"/> Y <input type="checkbox"/> N	<input type="checkbox"/> Y <input type="checkbox"/> N	<input type="checkbox"/> Y <input type="checkbox"/> N	<input type="checkbox"/> Y <input type="checkbox"/> N	<input type="checkbox"/> Y <input type="checkbox"/> N
Diarrhoea ³	<input type="checkbox"/> Y <input type="checkbox"/> N	<input type="checkbox"/> Y <input type="checkbox"/> N	<input type="checkbox"/> Y <input type="checkbox"/> N	<input type="checkbox"/> Y <input type="checkbox"/> N	<input type="checkbox"/> Y <input type="checkbox"/> N	<input type="checkbox"/> Y <input type="checkbox"/> N	<input type="checkbox"/> Y <input type="checkbox"/> N	<input type="checkbox"/> Y <input type="checkbox"/> N	<input type="checkbox"/> Y <input type="checkbox"/> N	<input type="checkbox"/> Y <input type="checkbox"/> N	<input type="checkbox"/> Y <input type="checkbox"/> N	<input type="checkbox"/> Y <input type="checkbox"/> N	<input type="checkbox"/> Y <input type="checkbox"/> N	<input type="checkbox"/> Y <input type="checkbox"/> N

¹ Close contact: A person having had face-to-face contact (≤2 metres) or was in a closed environment with a COVID-19 case; this includes, amongst others, all persons living in the same household as a COVID-19 case and, people working closely in the same environment as a case. A healthcare worker or other person providing direct care for a COVID-19 case, while not wearing recommended personal protective equipment or PPE (e.g., gowns, gloves, NIOSH-certified disposable N95 respirator, eye protection). A contact in an aircraft sitting within two seats (in any direction) of the COVID-19 case, travel companions or persons providing care, and crew members serving in the section of the aircraft where the index case was seated. Casual contact: Anyone not meeting the definition for a close contact but with possible exposure. ² Chose from: Spouse, Aunt, Child, Class mate, Colleague, Cousin, Father, Friend, Grandfather, Grandmother, Healthcare worker taking care of, Mother, Nephew, Niece, Other relative, Uncle. ³ Diarrhoea defined as three or more loose stools in a 24-hour period.

APPENDIX D: COVID-19 BASELINE RISK ASSESSMENT

					Likelihood						
					Very Unlikely	Unlikely	Possible	Likely	Very Likely		
					Severity	Negligible	1	2	3	4	5
						Minor	2	4	6	8	10
						Moderate	3	6	9	12	15
						Major	4	8	12	16	20
						Extreme	5	10	15	20	25
Hazard	L	S	Risk	Control Measures	L	S	RR	Persons at Risk			
Exposure from others due to: 1. Living with someone with a confirmed case of COVID-19. 2. Have come into close contact (within 2 metres for 15 minutes or more) with a confirmed case of COVID-19. 3. Being advised by a public health authority that contact with a diagnosed case has occurred.				<ul style="list-style-type: none"> To follow government action of self-isolation and only to leave house on the following circumstances: for medical reason; to shop for necessary food supplies; for exercise once per day; and for essential works including those deemed 'key workers' Any existing individual risk assessments (disability, young persons or new / expectant mothers) to be reviewed Maintain contact with line management and Human Resources (HR) and to follow company policy / guidance. Travel is only required for essential travel; reduce the amount of time using public transport and to implement social distancing where possible (2m clearance from persons and not to travel in groups of more than 2 unless it is immediate family) To continue following ongoing government guidance Stay at home and only attend hospital in an emergency. Do not attend GP surgery and phone (Insert No) if further advice is required Company to ensure extremely vulnerable persons are shielding themselves and following their specific medical advice issued to them no later than 29/3/2020 Always follow good hygiene measures Avoid all visitors to your home unless they are providing a medical requirement Do not approach delivery staff, allow packages to be left on the doorstep Do not take any antibiotics as they do not work against viruses. 				Individual Workers			

					Likelihood						
					Very Unlikely	Unlikely	Possible	Likely	Very Likely		
					Severity	Negligible	1	2	3	4	5
						Minor	2	4	6	8	10
						Moderate	3	6	9	12	15
						Major	4	8	12	16	20
						Extreme	5	10	15	20	25
Hazard	L	S	Risk	Control Measures	L	S	RR	Persons at Risk			
Suspected case whilst working on site				<p>If a worker develops a high temperature or a persistent cough while at work, they should:</p> <ol style="list-style-type: none"> Return home immediately Avoid touching anything Cough or sneeze into a tissue and put it in a bin, or if they do not have tissues, cough and sneeze into the crook of their elbow. They must then follow the guidance on self-isolation and not return to work until their period of self-isolation has been completed. 				Individual workers			
General travel including foreign travel				<ol style="list-style-type: none"> Do not travel unless you cannot work from home or deemed a key worker – implement teleconferencing for meetings Where an individual has recently visited these countries, they should self / home isolate themselves until further notice from the government (lockdown measures continue to apply) Please continue to follow any further national government advice provided Where an occupational health (OH) service provider has been appointed, please seek additional advice or concerns through this service All persons to limit their use of public transport. Where travel is essential, please use private single occupancy where possible 				Individual workers			
Access / egress to site				<p>Where possible, please consider and implement the following practices:</p> <ol style="list-style-type: none"> Stop all non-essential visitors Introduce staggered start and finish times to reduce congestion and contact at all times Monitor site access points to enable social distancing – you may need to change the number of access points, either increase to reduce congestion or decrease to enable monitoring Remove or disable entry systems that require skin contact e.g. fingerprint scanners Require all workers to wash or clean their hands before entering or leaving the site 				Individual workers			

					Likelihood						
					Very Unlikely	Unlikely	Possible	Likely	Very Likely		
					Severity	Negligible	1	2	3	4	5
						Minor	2	4	6	8	10
						Moderate	3	6	9	12	15
						Major	4	8	12	16	20
						Extreme	5	10	15	20	25
Hazard	L	S	Risk	Control Measures	L	S	RR	Persons at Risk			
				<ol style="list-style-type: none"> Allow plenty of space (two metres) between people waiting to enter site Regularly clean common contact surfaces in reception, office, access control and delivery areas e.g. scanners, turnstiles, screens, telephone handsets, desks, particularly during peak flow times Reduce the number of people in attendance at site inductions and consider holding them outdoors wherever possible Drivers should remain in their vehicles if the load will allow it and must wash or clean their hands before unloading goods and materials. 							
Inclement weather – cold temperature allows disease to survive				<ol style="list-style-type: none"> All persons to dress appropriately for the weather Welfare facilities provided to shelter from the elements Maintain good hygiene measures at all times Appropriate respiratory protective equipment (RPE) masks to be considered as last resort however face fit test (FFT) must be completed to ensure mask effectiveness. It is advised to speak to your H&S competent person on these matters and supplies should be reserved for medical staff as it has been documented that supplies have been difficult to procure 				Individual workers			
Poor hygiene				<ol style="list-style-type: none"> Wash your hands thoroughly and regularly. Use soap and water for at least 20 seconds. Use alcohol-based hand sanitiser if soap and water is not available and hand washing technique to be adopted as directed Avoid touching your face/eyes/nose/mouth with unwashed hands and cover your cough or sneeze with a tissue then throw it in the bin. Provide additional hand washing facilities to the usual welfare facilities if a large spread out site or significant numbers of personnel on site Regularly clean the hand washing facilities and check soap and sanitiser levels Provide suitable and sufficient rubbish bins for hand towels with regular removal and disposal. Sites will need extra supplies of soap, hand sanitiser and paper towels and these should be securely stored. 				Individual workers			

					Likelihood						
					Very Unlikely	Unlikely	Possible	Likely	Very Likely		
					Severity	Negligible	1	2	3	4	5
						Minor	2	4	6	8	10
						Moderate	3	6	9	12	15
						Major	4	8	12	16	20
						Extreme	5	10	15	20	25
Hazard	L	S	Risk	Control Measures	L	S	RR	Persons at Risk			
				7. Restrict the number of people using toilet facilities at any one time e.g. use a welfare attendant. Wash hands before and after using the facilities. Enhance the cleaning regimes for toilet facilities particularly door handles, locks and the toilet flush. Portable toilets should be avoided wherever possible, but where in use these should be cleaned and emptied more frequently.							
Canteen - exposure from large numbers of persons				<ol style="list-style-type: none"> 1. The workforce should also be required to stay on site once they have entered it and not use local shops. 2. Dedicated eating areas should be identified on site to reduce food waste and contamination 3. Break times should be staggered to reduce congestion and contact at all times 4. Hand cleaning facilities or hand sanitiser should be available at the entrance of any room where people eat and should be used by workers when entering and leaving the area 5. The workforce should be asked to bring pre-prepared meals and refillable drinking bottles from home 6. Workers should sit 2 metres apart from each other whilst eating and avoid all contact 7. Where catering is provided on site, it should provide pre-prepared and wrapped food only - Payments should be taken by contactless card wherever possible and Crockery, eating utensils, cups etc. should not be used 8. Drinking water should be provided with enhanced cleaning measures of the tap mechanism introduced 9. Tables should be cleaned between each use 10. All rubbish should be put straight in the bin and not left for someone else to clear up 11. All areas used for eating must be thoroughly cleaned at the end of each break and shift, including chairs, door handles, vending machines and payment devices. 				Individual Workers			

					Likelihood						
					Very Unlikely	Unlikely	Possible	Likely	Very Likely		
					Severity	Negligible	1	2	3	4	5
						Minor	2	4	6	8	10
						Moderate	3	6	9	12	15
						Major	4	8	12	16	20
						Extreme	5	10	15	20	25
Hazard	L	S	Risk	Control Measures	L	S	RR	Persons at Risk			
Use of Changing facilities, showers and drying rooms				<ol style="list-style-type: none"> 1. Introduce staggered start and finish times to reduce congestion and contact at all times 2. Introduce enhanced cleaning of all facilities throughout the day and at the end of each day 3. Consider increasing the number or size of facilities available on site if possible 4. Based on the size of each facility, determine how many people can use it at any one time to maintain a distance of two metres 5. Provide suitable and sufficient rubbish bins in these areas with regular removal and disposal. 				Individual workers			